

A woman with long blonde hair and blue eyes, wearing a dark green suit, is seated on a blue tufted sofa. She is holding a red, textured, rectangular clutch bag. In front of her on the sofa is another red, textured bag, which appears to be a jewelry box or a smaller clutch. The background is a plain, light-colored wall.

WOLF

ESTD 1834

2023

WOLF
ESTD 1834

PROTECTING LEGACY

Over 185 years old,
five generation family-owned brand,
crafting the spaces where legacies live.





LEFT: PHILIP WOLF IV

Our legacy...

1834

Philip Wolf I, a successful German silversmith, discovered that his silver pieces sold better when presented in beautiful boxes. As he began selling more boxes than silver, he refocused his craft thus marking the beginning of WOLF.

1962

Over time, his highly automated factory employed over 300 people and was recognised as the largest manufacturer of jewellery boxes and display materials for all of Great Britain and much of Europe.

1895

Then came his son Philip Wolf II, who convinced his father to move the business to Malmö, Sweden. As time passed, his sons, Ernst and Philip III, proudly continued the tradition of box making.

1988

With the economy and business flourishing in England, the time was right for the Wolf family to assume the biggest challenge they had ever undertaken: tackling the USA and Canadian markets. It was up to Simon Philip V, with guidance from his father Philip IV, to persevere and continue to expand and diversify the company.

1930

Philip Wolf III continued to expand the Swedish factory into its third generation of box making. Progress was slow but steady and then, in 1962, his first son, Philip Wolf IV, immigrated to England to open a new factory.

TODAY

The Wolf family legacy proudly continues, focusing on innovative designs, technological advancements, the pursuit of the perfect design and the protection of your legacies.



Your legacy...

As a five-generation family company, we understand that extraordinary objects are representations of extraordinary moments in life.

Since 1834, the WOLF mark has been a symbol of decades of innovation and the pursuit of the perfect design.

We believe for a legacy to endure it must be nourished and upheld.

Every day in beautiful WOLF cases around the world, centuries-old treasures live side-by-side with exquisite new designs.

We are dedicated to honouring people's stories and the legacies they entrust to us.

Protect your legacy with WOLF

Sustainability

Over the last several years, we have deepened our commitment to sustainability across the company.

We source sustainable packaging and use materials like 100% recycled leather.

Because it matters to us, but also because our commitment to quality is intertwined with the need for sustainable processes and materials.

Protecting your legacy, protecting the planet.

Honouring Craft at Every Level



WOLF
Labour

Our workshops and the people who work in them are the bedrock of our business. We provide safe working conditions, liveable wages and work hard to ensure equal labour rights. Because the quality of life of our artisans directly affects the quality of our products and because we care about our impact on the environment, we also ensure that our factories meet emissions standards and practices.

Impact is in the Details



WOLF
Packaging

We only use recyclable, sustainable and eco-friendly packaging that is made of 70% post-consumer recycled waste. So you can feel good about unboxing your WOLF product as all packaging can be re-used or placed in a recycling bin.

Leather, Reimagined



WOLF
Recycles

Our CEO Simon Wolf has continued his family legacy in many ways, including a deep commitment to environmentalism and protection of animals. To protect your legacy, which is WOLF's core aim, we must do our part to protect the health of the planet. All of our watch winders are wrapped in 100% vegan leather; because the highest quality and luxury can also be sustainable.

New and Innovative Packaging

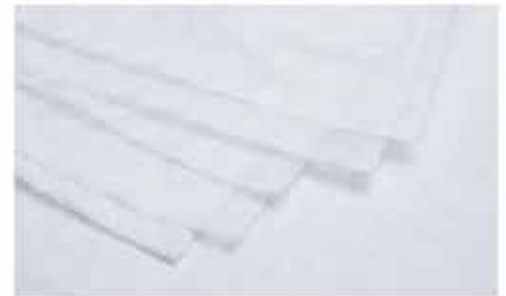

WOLF
Materials

At WOLF, we only use certified FSC 100% recycled paper, certified recycled corrugated cardboard and 100% recycled cotton and polyester materials. Our new accessories collection is 95% sustainable, with materials made from recycled PVC, apple pulp and plastic bottles.

Minimising Effects on Planet Earth



WOLF
Change

WOLF has a long history of caring about climate. Philip Wolf III wrote about 'climate change', in his book, 'Land Drainage and its Dangers as Experienced in Sweden', 58 years before the term had been coined. Philip wrote on subjects related to how we were already affecting the climate of the earth.

Family Legacy of Conservation



WOLF
Conservation

Simon Wolf's grandfather created the Swedish Salmon and Trout Association. The inauguration took place in August of 1948 when he opened Håstad Mill. As a lifelong fisherman who cared deeply about the water quality and the impact the fishing industry had on the planet, it was one of his greatest achievements that continues to inspire Simon Wolf's commitment to conservation.

PATENTED TECHNOLOGY AND DESIGN

**OUR WALLETS AND CARDHOLDERS
ARE RFID PROTECTED**

RFID or Radio Frequency Identification are the information tags transmitted by bank cards and wireless payment cards.

We use an RFID blocking material sewn into the lining of all our wallets and laptop cases that cloaks the signal, rendering it unreadable by scanners used by identity thieves.







PATENTED TECHNOLOGY

**OUR JEWELLERY BOXES
FEATURE LUSTERLOC™**

Jewellery begins to lose its luster with
air contact and our patented LusterLoc™

formula neutralises the process.

LusterLoc™ protects your jewellery

for up to 35 years.

PATENTED TECHNOLOGY AND DESIGN

ONLY OUR WATCH WINDERS COUNT TURNS PER DAY

WOLF, first to count Turns Per Day, first with the unique Return To Start feature, first to engineer a safe Lock-in Cuff, now first with their patent pending “Dynamic Cuff”. One cuff, three sizes...genius.

Why guess when you can be precise,
WOLF, always innovating.

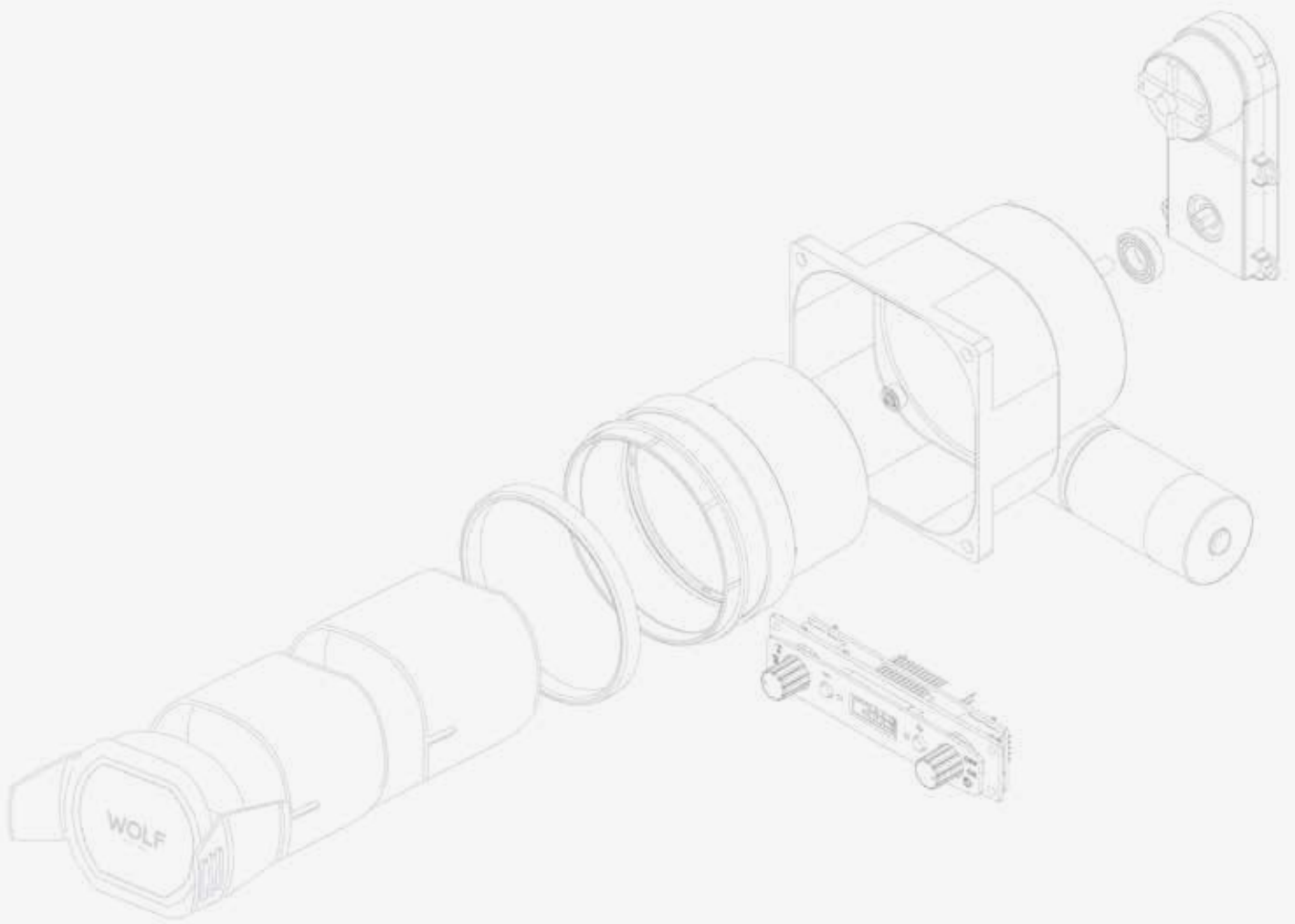

WATCH WINDERS / PAGE 18

TRAVEL WATCH WINDER

THE ROCKET	20
------------------	----

PROGRAMMABLE WATCH WINDERS

AXIS	22
BRITISH RACING.....	24
MODULE 4.1.....	26
PALERMO.....	28
ROADSTER.....	30
VICEROY.....	32

PRE-PROGRAMMED WATCH WINDERS

CORTIÇA	34
CUB.....	36
ELEMENTS	38

APP-CONTROLLED WATCH WINDERS

ATLAS	40
CHURCHILL.....	42
REGENT.....	46

WATCH STANDS / PAGE 48

TRAVEL WATCH STANDS

AXIS	50
BRITISH RACING.....	50
ELEMENTS	50
ROADSTER.....	50
VICEROY	50

SINGLE STATIC WATCH STANDS

AXIS	52
BRITISH RACING.....	52
ELEMENTS	52
ROADSTER.....	52
VICEROY	52

DOUBLE STATIC WATCH STANDS

AXIS	54
BRITISH RACING.....	54
ELEMENTS	54
ROADSTER.....	54
VICEROY	54

WATCH ROLLS / PAGE 56

AXIS	58
BRITISH RACING	58
CORTIÇA	58
ELEMENTS.....	60
MEMENTO MORI	60
PALERMO.....	60
ROADSTER	62
TUTTI FRUTTI	62

WATCH BOXES / PAGE 64

AXIS.....	66
BRITISH RACING.....	68
CORTIÇA.....	70
ELEMENTS.....	72
PALERMO.....	74
ROADSTER.....	76
VICEROY.....	78

JEWELLERY BOXES / PAGE 80

CAROLINE.....	82
PALERMO.....	84
SOPHIA.....	86
VAULT.....	88
ZOE.....	94

TRAVEL CASES / PAGE 96

CAROLINE.....	98
MARIA.....	100
PALERMO.....	102
SOPHIA.....	104
ZOE.....	106

SAFES / PAGE 108

ATLAS.....	112
CHURCHILL.....	116

SMALL LEATHER GOODS / PAGE 128

MIMI.....	130
SIGNATURE.....	134
W.....	138

COLLABORATIONS / PAGE 140

ANALOG/SHIFT.....	142
BEA BONGIASCA.....	144
WM BROWN.....	146





WATCH WINDERS

A WOLF watch winder is a handmade precision instrument that focuses on the health of your watch using patented technology. Only a WOLF counts Turns Per Day, all other winders simply use time to estimate rotations. With a Lock-in Dynamic Cuff, allowing for varying wrist sizes and unique Return To Start feature, WOLF's winders combine clever design with innovative technology. If you value your watch, then wind it in a WOLF.

THE ROCKET

TRAVEL WATCH WINDER



The Rocket: The world's smallest travel watch winder; small enough to cradle in the palm of your hand, operate seamlessly inside any hotel safe, pop into your overnight holdall or pack for an extended holiday away. Put simply The Rocket gives your watch the perfect wind anytime, anywhere.



EU RETAIL: €599.00

ITEM NO: 543210

THE ROCKET

BLACK

9.1CM L X 16CM W X 8.7CM H

AXIS

PROGRAMMABLE WATCH WINDER



Powder-coated and copper plated laser cut perforated steel melded with clean, sleek lines. AXIS drives a modern, bold look for safekeeping your timepieces. Our patented technology of counting rotations of the axis of your watch guarantees precise Turns Per Day. Bold luxury, faultless design, take AXIS for a spin.



EU RETAIL: €699.00



EU RETAIL: €769.00



EU RETAIL: €1,455.00



EU RETAIL: €2,139.00



EU RETAIL: €2,439.00



EU RETAIL: €3,615.00



EU RETAIL: €4,765.00

ITEM NO: 4691

SINGLE WINDER

COPPER PLATED / POWDER COATED

14CM L X 20.8CM W X 17.4CM H



COPPER PLATED

16



POWDER COATED

03

ITEM NO: 4692

SINGLE WINDER WITH STORAGE

COPPER PLATED / POWDER COATED

20CM L X 21CM W X 23CM H

ITEM NO: 4694

TRIPLE WINDER WITH STORAGE

COPPER PLATED / POWDER COATED

45.3CM L X 21CM W X 22.5CM H

ITEM NO: 4696

6PC WINDER

COPPER PLATED / POWDER COATED

40CM L X 16CM W X 34CM H

ITEM NO: 4693

DOUBLE WINDER WITH STORAGE

COPPER PLATED / POWDER COATED

33.9CM L X 20.8CM W X 22.5CM H

ITEM NO: 4695

4PC WINDER

COPPER PLATED / POWDER COATED

27.5CM L X 16CM W X 34CM H

ITEM NO: 4697

8PC WINDER

COPPER PLATED / POWDER COATED

52CM L X 16CM W X 34CM H

BRITISH RACING

PROGRAMMABLE WATCH WINDER



Classics are not created, they are born, destined to be one-off's, different, unique and above all else, timeless. British Racing has, in a very short span of time, become a classic, truly one of a kind.



EU RETAIL: €799.00

EU RETAIL: €849.00

EU RETAIL: €1,565.00



EU RETAIL: €2,389.00



EU RETAIL: €2,609.00



EU RETAIL: €3,965.00



EU RETAIL: €4,969.00

ITEM NO: 7931

SINGLE WINDER

GREEN / BLACK

14.8CM L x 18.6CM W x 20.5CM H



GREEN
41



BLACK
02

ITEM NO: 7921

SINGLE WINDER WITH STORAGE

GREEN / BLACK

20.5CM L X 20.3CM W X 22.9CM H

ITEM NO: 7923

TRIPLE WINDER WITH STORAGE

GREEN / BLACK

45.1CM L X 20.3CM W X 22.9CM H

ITEM NO: 7924

6PC WINDER

GREEN / BLACK

41.3CM L X 16.5CM W X 35CM H

ITEM NO: 7922

DOUBLE WINDER WITH STORAGE

GREEN / BLACK

33.7CM L X 20.3CM W X 22.9CM H

ITEM NO: 7930

4PC WINDER

GREEN / BLACK

41.3CM L X 16.5CM W X 35CM H

ITEM NO: 7925

8PC WINDER

GREEN / BLACK

54CM L X 16.5CM W X 35CM H

MODULE 4.1

PROGRAMMABLE WATCH WINDER



The ultimate, the one, the only. 4.1 is the solution to the dilemma, "how many winders?" You own one watch no problem, you have three, we can take care of that. Once you buy another watch, buy another 4.1 winder. They connect and are powered together. Build your own watch winder tower, be creative!



EU RETAIL: €519.00



ITEM NO: 454011

SINGLE WINDER

BLACK

12.2CM L X 16.7CM W X 16CM H

PALERMO

PROGRAMMABLE WATCH WINDER



Sophistication must be effortless. Charm and style has to come with ease. Palermo takes cues from its namesake city on the side of a mountain by the sea. Sumptuous leathers in traditional colours with flair, pewter, black anthracite and rose gold sparkle and the Ferrari red tempts. Your watches deserve a classic home.



EU RETAIL: €869.00

ITEM NO: 2137

SINGLE WATCH WINDER WITH JEWELLERY STORAGE

PEWTER / BLACK ANTHRACITE / RED / ROSE GOLD

19.7CM L X 20.3CM W X 23CM H



PEWTER

78



BLACK
ANTHRACITE

02



RED

72



ROSE GOLD

16

ROADSTER

PROGRAMMABLE WATCH WINDER



Take your fine timepieces for a ride in a Roadster. Aged wood dashboards, chrome spoked wheels, leather that is glove soft. Roadster – inspired by the best of British motorcars, Jaguar, Aston Martin, Bristol and the like. The ebony macassar polished wood in our single, double, triple, 4, 6 and 8 piece watch winders, provides the perfect backdrop for your watch collection.



EU RETAIL: €699.00



EU RETAIL: €769.00



EU RETAIL: €1,455.00



EU RETAIL: €2,139.00



EU RETAIL: €2,439.00



EU RETAIL: €3,615.00



EU RETAIL: €4,765.00

ITEM NO: 457156

SINGLE WINDER WITH STORAGE

BLACK

19.7CM L X 20.3CM W X 23CM H

ITEM NO: 457256

DOUBLE WINDER WITH STORAGE

BLACK

34CM L X 20.3CM W X 23CM H

ITEM NO: 457056

SINGLE WINDER

BLACK

14CM L X 20.3CM W X 17.4CM H

ITEM NO: 457356

TRIPLE WINDER WITH STORAGE

BLACK

45.5CM L X 20.3CM W X 23CM H

ITEM NO: 459156

4PC WINDER

BLACK

27.5CM L X 16.5CM W X 33.8CM H

ITEM NO: 459256

6PC WINDER

BLACK

40CM L X 16.5CM W X 33.8CM H

ITEM NO: 459356

8PC WINDER

BLACK

52CM L X 16.5CM W X 33.8CM H

VICEROY

PROGRAMMABLE WATCH WINDER



Rule over your collection with authority with a timeless Viceroy watch winder. A modern classic that exudes an understated elegance. Choose from single up to 8 modules and be assured your timepiece will be wound with complete accuracy. Clockwise, anti-clockwise or both, we will take care of your watch for all time.



EU RETAIL: €699.00



EU RETAIL: €769.00



EU RETAIL: €1,455.00



EU RETAIL: €2,139.00



EU RETAIL: €2,439.00



EU RETAIL: €3,615.00



EU RETAIL: €4,765.00

ITEM NO: 456102

SINGLE WINDER WITH STORAGE

BLACK

19.7CM L X 20.8CM W X 22.6CM H

ITEM NO: 456702

4PC WINDER

BLACK

27.5CM L X 16.5CM W X 33.5CM H

ITEM NO: 456202

DOUBLE WINDER WITH STORAGE

BLACK

34CM L X 21CM W X 23CM H

ITEM NO: 456802

6PC WINDER

BLACK

40.5CM L X 16.8CM W X 33CM H

ITEM NO: 456002

SINGLE WINDER

BLACK

14CM L X 20.8CM W X 17.4CM H

ITEM NO: 456302

TRIPLE WINDER WITH STORAGE

BLACK

45.5CM L X 21CM W X 22.8CM H

ITEM NO: 456902

8PC WINDER

BLACK

50.8CM L X 16.8CM W X 33CM H

CORTIÇA

PRE-PROGRAMMED WATCH WINDER



Inspired by the original box for a very special watch, Cortiça is handmade from natural cork, a sustainable material grown in Portuguese forests. Featuring a unique hexagonal design with metal edging detail and forest green recycled material interior. Choose from Cortiça's watch winder, watch roll and 4 piece watch box.



EU RETAIL: €639.00

ITEM NO: 6681

SINGLE WINDER

NATURAL CORK

14CM L X 17.5CM W X 15.3 CM H



NATURAL CORK

61

CUB

PRE-PROGRAMMED WATCH WINDER



Young, smart and uncomplicated, our Cubs take care of your watch with ease. Six sides perfectly proportioned to encase your timepiece safely and precisely. Never miss a beat in your busy life. Choose from over 12 vegan leather colours.



EU RETAIL: €389.00



EU RETAIL: €389.00



EU RETAIL: €389.00



EU RETAIL: €389.00



EU RETAIL: €389.00



EU RETAIL: €389.00



EU RETAIL: €389.00



EU RETAIL: €389.00



EU RETAIL: €389.00



EU RETAIL: €389.00



EU RETAIL: €389.00



EU RETAIL: €389.00



EU RETAIL: €755.00



EU RETAIL: €755.00



EU RETAIL: €755.00

ITEM NO: 4611

SINGLE CUB WINDER WITH COVER

BORDEAUX / RED / PINK / ORANGE / YELLOW / GREEN
 HUNTER GREEN / BLUE / NAVY / COGNAC / BROWN / BLACK
 14CM L X 15.4CM W X 14.8CM H



BORDEAUX
26



RED
72



PINK
90



ORANGE
39



YELLOW
92



GREEN
43



HUNTER GREEN
41



BLUE
28



NAVY
17



COGNAC
27



BROWN
06



BLACK
03

ITEM NO: 4612

DOUBLE CUB WINDER WITH COVER

NAVY / BROWN / BLACK
 26CM L X 15.4CM W X 14.8CM H

ELEMENTS

PRE-PROGRAMMED WATCH WINDER



Drawing inspiration from the world around us, Elements uses colour and pattern in a contemporary design across watch winders, watch boxes and travel watch rolls. Choose from the blues of Water, orange and magenta of Fire or greens and browns of Earth.



EU RETAIL: €339.00

ITEM NO: 6651

SINGLE CUB WINDER WITH COVER

EARTH / WATER / FIRE

14CM L X 15.4CM W X 14.8CM H



EARTH
30



WATER
71



FIRE
72

ATLAS

APP-CONTROLLED WATCH WINDER



Designed with beauty and function in mind the Atlas is forged in American steel, UL tested and certified for burglary & fire. Available in two stunning high gloss finishes of onyx or titanium and lined with LusterLoc™ to stop jewellery from tarnishing for up to 35 years. Choose from 4 to 20 winder modules (in groups of 4) to ensure that your collection keeps perfect time. Atlas is the solution for the protection of your most precious valuables.



EU RETAIL: €27,435.00

EU RETAIL: €27,435.00

EU RETAIL: €31,459.00

EU RETAIL: €31,459.00



EU RETAIL: €35,475.00

EU RETAIL: €35,475.00

EU RETAIL: €39,495.00

EU RETAIL: €39,495.00



EU RETAIL: €43,515.00

EU RETAIL: €43,515.00

ITEM NO: 4904

4 PIECE WINDER SAFE

ONYX / TITANIUM

55.9CM L X 61CM W X 101.6CM H

ITEM NO: 4912

12 PIECE WINDER SAFE

ONYX / TITANIUM

55.9CM L X 61CM W X 101.6CM H



ONYX

64



TITANIUM

65

ITEM NO: 4918

8 PIECE WINDER SAFE

ONYX / TITANIUM

55.9CM L X 61CM W X 101.6CM H

ITEM NO: 4916

16 PIECE WINDER SAFE

ONYX / TITANIUM

55.9CM L X 61CM W X 101.6CM H

ITEM NO: 4920

20 PIECE WINDER SAFE

ONYX / TITANIUM

55.9CM L X 61CM W X 101.6CM H

CHURCHILL

APP-CONTROLLED WATCH WINDER

There is no limit to what we can craft for you. We begin with the size and configuration of the interior of the safe. You choose how many WOLF Bluetooth app controlled watch winders and the number of drawers for watches, jewellery or other valuables. We will then assist you in selecting the exterior for your safe, either sumptuous leathers or beautifully polished hardwoods. For more information and to start your Churchill design project visit www.wolf1834.com/churchill-safes



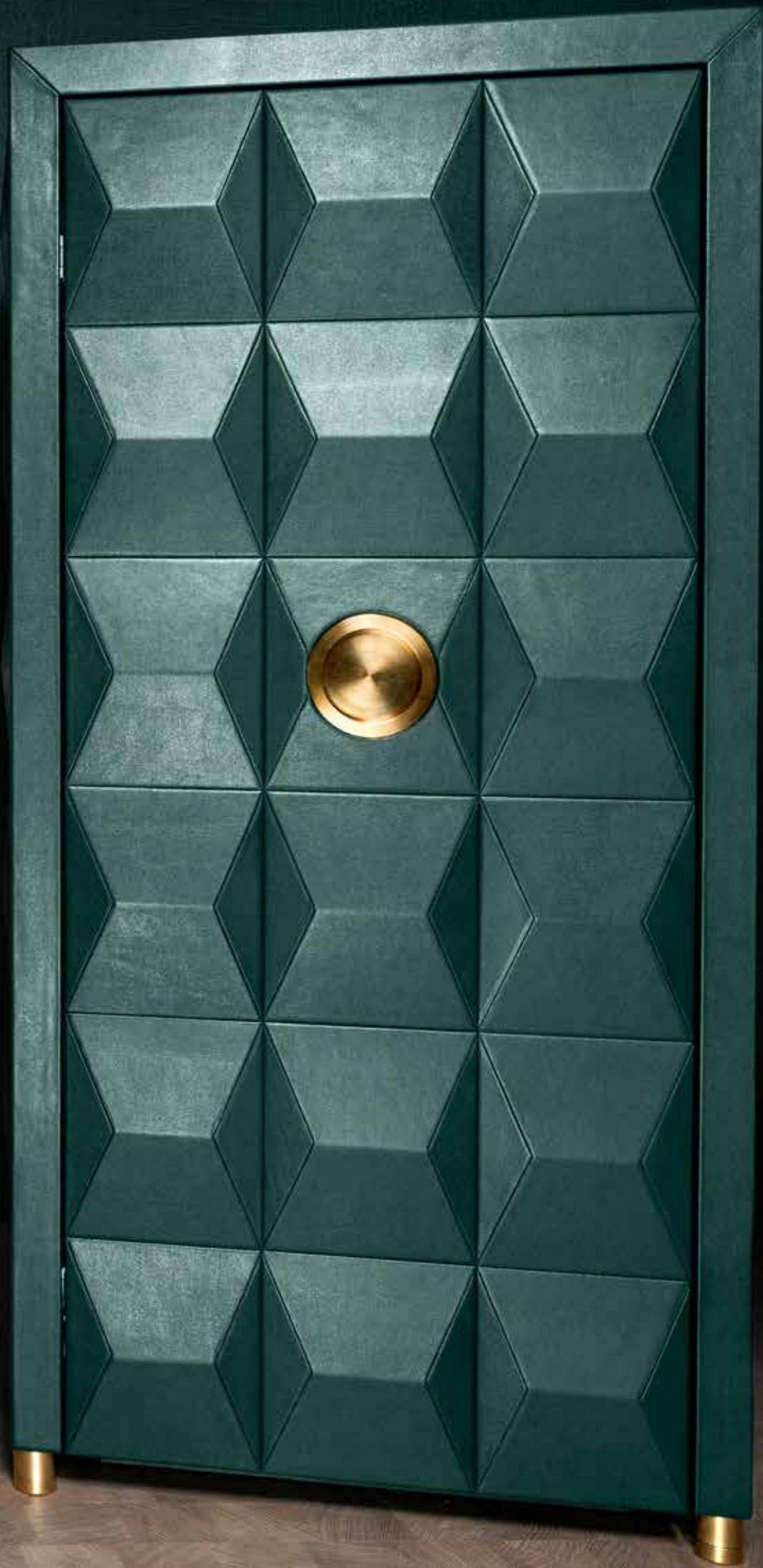

CHURCHILL

APP-CONTROLLED WATCH WINDER

The Churchill is a custom safe crafted by the artisans at WOLF and made for you. Select the leather, hardware colour and interior configurations of drawers and winders to ensure you bring home a piece as unique as you.

Starting retail price €113,295.00



NOTE: Churchill safes are custom made - prices shown as an approximate starting price



EU RETAIL STARTING AT €123,195.00

CHURCHILL 16 PIECE WINDER SAFE
BRITISH RACING GREEN

REGENT

APP-CONTROLLED WATCH WINDER



Serious luxury for the watch lover in us all. Regent watch cabinets are handcrafted in wood and glass and integrated with WOLF's app to give you complete control of 12 individual watch winders. Created for true watch aficionados to protect your most precious timepieces and valuables and to keep your watches wound to perfection.



EU RETAIL: €12,899.00



EU RETAIL: €12,899.00

ITEM NO: 468040

12 PIECE CABINET WINDER

ZEBRA BLACK



ZEBRA BLACK

40



BLACK

70

ITEM NO: 468070

12 PIECE CABINET WINDER

BLACK



WATCH STANDS

Your watches are more than a timepiece, they are a source of pride and a measure of success. Proudly display your watch in your home, on your bedside table or office desk with a WOLF watch stand.

WOLF watch stands feature a single or double soft padded top cushion and secure base, connected with a reinforced steel pole - keeping your watch safe, scratch-free and accessible.

TRAVEL

WATCH STAND



Travelling with your watch? The WOLF Travel Watch Stand packs flat into a handy travel case, simply unfold for use when you arrive at your destination.

WOLF Travel Watch Stands feature a double soft padded top cushion and secure base with coin/cufflink trays, connected with our patented folding mechanism, perfect for keeping your watch safe, scratch-free and accessible.

AXIS



EU RETAIL: €155.00

BRITISH RACING



EU RETAIL: €155.00

ELEMENTS



EU RETAIL: €155.00

ROADSTER



EU RETAIL: €155.00

VICEROY



EU RETAIL: €155.00

ITEM NO: 4853

AXIS SINGLE TRAVEL WATCH STAND
POWDER COATED / COPPER PLATED
11CM L x 11CM W x 16CM H



POWDER COATED
03



COPPER PLATED
16

ITEM NO: 4855

ELEMENTS TRAVEL WATCH STAND
EARTH / WATER / FIRE
11CM L x 11CM W x 16CM H



EARTH
30



WATER
71



FIRE
72

ITEM NO: 4854

BRITISH RACING TRAVEL WATCH STAND
GREEN / BLACK
11CM L x 11CM W x 16CM H



GREEN
41



BLACK
02

ITEM NO: 4852

ROADSTER TRAVEL WATCH STAND
BLACK
11CM L x 11CM W x 16CM H



BLACK
02

ITEM NO: 4851

VICEROY TRAVEL WATCH STAND
BLACK
11CM L x 11CM W x 16CM H



BLACK
02

SINGLE STATIC

WATCH STAND



AXIS

EU RETAIL: €105.00

BRITISH RACING

EU RETAIL: €105.00

ELEMENTS

EU RETAIL: €105.00

ROADSTER

EU RETAIL: €105.00

VICEROY

EU RETAIL: €105.00

ITEM NO: 4863

AXIS SINGLE STATIC WATCH STAND

POWDER COATED / COPPER PLATED

11CM L x 11CM W x 12CM H

POWDER COATED
03COPPER PLATED
16

ITEM NO: 4865

ELEMENTS SINGLE STATIC WATCH STAND

EARTH / WATER / FIRE

11CM L x 11CM W x 12CM H

EARTH
30WATER
71FIRE
72

ITEM NO: 4864

BRITISH RACING SINGLE STATIC WATCH STAND

GREEN / BLACK

11CM L x 11CM W x 12CM H

GREEN
41BLACK
02

ITEM NO: 4862

ROADSTER SINGLE STATIC WATCH STAND

BLACK

11CM L x 11CM W x 12CM H

BLACK
02

ITEM NO: 4861

VICEROY SINGLE STATIC WATCH STAND

BLACK

11CM L x 11CM W x 12CM H

BLACK
02

DOUBLE STATIC

WATCH STAND



AXIS

EU RETAIL: €119.00

BRITISH RACING

EU RETAIL: €119.00

ELEMENTS

EU RETAIL: €119.00

ROADSTER

EU RETAIL: €119.00

VICEROY

EU RETAIL: €119.00

ITEM NO: 4873

AXIS DOUBLE STATIC WATCH STAND

POWDER COATED / COPPER PLATED

11CM L X 16CM W X 12CM H

POWDER
COATED
03COPPER
PLATED
16

ITEM NO: 4874

BRITISH RACING DOUBLE STATIC WATCH STAND

GREEN / BLACK

11CM L X 16CM W X 12CM H

GREEN
41BLACK
02

ITEM NO: 4875

ELEMENTS DOUBLE STATIC WATCH STAND

EARTH / WATER / FIRE

11CM L X 16CM W X 12CM H

EARTH
30WATER
71FIRE
72

ITEM NO: 487202

ROADSTER DOUBLE STATIC WATCH STAND

BLACK

11CM L X 16CM W X 12CM H

ITEM NO: 487102

VICEROY DOUBLE STATIC WATCH STAND

BLACK

11CM L X 16CM W X 12CM H





WATCH ROLLS

WOLF's luxurious and ingenious travel watch rolls combine the finest leathers with five generations of handmade tradition. Choose from single, double or triple watch rolls with secret storage compartments to keep your timepieces and valuables safe. When you travel with a WOLF watch roll, you're travelling with tradition.



AXIS



EU RETAIL: €285.00

BRITISH RACING



EU RETAIL: €69.00



EU RETAIL: €295.00

CORTIÇA



EU RETAIL: €439.00



POWDER
COATED
03



COPPER
PLATED
16

ITEM NO: 4884

AXIS TRIPLE WATCH ROLL

POWDER COATED / COPPER PLATED

20.5CM L X 8CM W X 8CM H



GREEN
41



BLACK
02

ITEM NO: 7920

BRITISH RACING SINGLE WATCH ROLL

GREEN / BLACK

7.3CM L X 8.3CM W X 8.3CM H

ITEM NO: 7929

BRITISH RACING TRIPLE WATCH ROLL

GREEN / BLACK

7.3CM L X 8.3CM W X 8.3CM H



NATURAL CORK
61

ITEM NO: 6683

CORTICA TRIPLE HEXAGON WATCH ROLL

NATURAL CORK

19.7CM L X 9.6CM W X 8.3CM H



ELEMENTS



EU RETAIL: €69.00



EU RETAIL: €209.00



MEMENTO MORI



EU RETAIL: €295.00



PALERMO



EU RETAIL: €279.00

EARTH
30WATER
71FIRE
72

ITEM NO: 6653

ELEMENTS

SINGLE WATCH ROLL

EARTH / WATER / FIRE
7.3CM L X 8.3 CM W X 8.3CM H

ITEM NO: 6652

ELEMENTS

TRIPLE WATCH ROLL

EARTH / WATER / FIRE
20.5CM L X 8CM W X 8CM HBLACK
02RED
72

ITEM NO: 4934

MEMENTO MORI TRIPLE WATCH ROLL

BLACK / RED
20.5CM L X 8CM W X 8CM HPEWTER
78BLACK
ANTHRACITE
02RED
72ROSE GOLD
16

ITEM NO: 2139

PALERMO DOUBLE WATCH ROLL + JEWELLERY CASE

PEWTER / BLACK ANTHRACITE / RED / ROSE GOLD
20.5CM L X 8CM W X 8CM H



ROADSTER

EU RETAIL: €285.00

TUTTI FRUTTI

EU RETAIL: €69.00

BLACK
56

ITEM NO: 4778

ROADSTER TRIPLE WATCH ROLL

BLACK

20.5CM L X 8CM W X 8CM H

RED
72PINK
90ORANGE
39

ITEM NO: 6801

TUTTI FRUTTI SINGLE WATCH ROLL

RED / PINK / ORANGE / YELLOW / GREEN / BLUE

7.3CM L X 8.3CM W X 8.3CM H

YELLOW
92GREEN
43BLUE
28



WATCH BOXES

WOLF watch boxes keep your watches safe and organised in style. Featuring suspended watch cuffs, USB charging port, storage options for cufflinks and watch straps. Available for 6, 8, 10 or 15 timepieces. Give your collection the watch box it deserves, choose WOLF.



AXIS



Powder-coated and copper plated laser cut perforated steel melded with clean, sleek lines. AXIS drives a modern, bold look for safekeeping your timepieces. Bold luxury, faultless design, take AXIS for a spin.



EU RETAIL: €455.00



EU RETAIL: €495.00



EU RETAIL: €529.00



EU RETAIL: €679.00

ITEM NO: 4880

8 PIECE WATCH BOX

COPPER PLATED / POWDER COATED

26.7CM L X 22.9CM W X 9.5CM H

ITEM NO: 4882

10 PIECE WATCH BOX WITH DRAWER

COPPER PLATED / POWDER COATED

32.7CM L X 22.9CM W X 13.6CM H

ITEM NO: 4881

10 PIECE WATCH BOX

COPPER PLATED / POWDER COATED

32.7CM L X 22.9CM W X 9.5CM H

ITEM NO: 4883

15 PIECE WATCH BOX

COPPER PLATED / POWDER COATED

32.7CM L X 32.39CM W X 9.53CM H



COPPER PLATED

16



POWDER COATED

03

BRITISH RACING



Classics are not created, they are born, destined to be one-off's, different, unique and above all else, timeless. British Racing has, in a very short span of time, become a classic, truly one of a kind.



EU RETAIL: €515.00



EU RETAIL: €575.00



EU RETAIL: €635.00



EU RETAIL: €719.00

ITEM NO: 7926

8PC WATCH BOX

GREEN / BLACK

26.7CM L X 22.9CM W X 10.2CM H

ITEM NO: 7928

10PC WATCH BOX WITH STORAGE

GREEN / BLACK

33CM L X 22.9CM W X 15.3CM H

ITEM NO: 7927

10PC WATCH BOX

GREEN / BLACK

33CM L X 22.9CM W X 10.2CM H

ITEM NO: 7932

15PC WATCH BOX

GREEN / BLACK

40.7CM L x 40.7CM W x 20.4CM H



GREEN

41



BLACK

02

CORTIÇA



Inspired by the original box for a very special watch, Cortiça is handmade from natural cork, a sustainable material grown in Portuguese forests. Featuring a unique hexagonal design with metal edging detail and forest green recycled material interior. Choose from Cortiça's watch winder, watch roll and 4 piece watch box.



EU RETAIL: €469.00

ITEM NO: 6682

4PC WATCH BOX

NATURAL CORK

26.7CM L X 13.4CM W X 10.8CM H



NATURAL CORK

61

ELEMENTS



Drawing inspiration from the world around us, Elements uses colour and pattern in a contemporary design in our classic 10 piece watch box. Choose from the blues of Water, orange and magenta of Fire or greens and browns of Earth.



EU RETAIL: €349.00

ITEM NO: 6654

10 PIECE WATCH BOX

EARTH / WATER / FIRE

33CM L X 22.9CM W X 10.2CM H



EARTH
30



WATER
71



FIRE
72

PALERMO



Sophistication must be effortless. Charm and style has to come with ease. Palermo takes cues from its namesake city on the side of a mountain by the sea. Sumptuous leathers in traditional colours with flair, pewter, black anthracite and rose gold sparkle and the Ferrari red tempts. Your watches deserve a classic home.



EU RETAIL: €345.00

ITEM NO: 2138

6 PIECE WATCH BOX

ROSE GOLD / BLACK ANTHRACITE / RED / PEWTER

22.25CM L X 23CM W X 9CM H



ROSE GOLD

16



BLACK
ANTHRACITE

02



RED

72



PEWTER

78

ROADSTER



Take your fine timepieces for a ride in a Roadster. Aged wood dashboards, chrome spoked wheels, leather that is glove soft. Roadster – inspired by the best of British motorcars, Jaguar, Aston Martin, Bristol and the like. The ebony macassar polished wood in our 8, 10 and 15 piece watchboxes, provides the perfect backdrop for your watch collection.



EU RETAIL: €455.00



EU RETAIL: €495.00



EU RETAIL: €529.00



EU RETAIL: €679.00

ITEM NO: 477556
10PC WATCH BOX
 BLACK
 33CM L X 23CM W X 9.5CM H

ITEM NO: 477656
10PC WATCH BOX WITH STORAGE
 BLACK
 33CM L X 23CM W X 14CM H

ITEM NO: 477456
8PC WATCH BOX
 BLACK
 27CM L X 23CM W X 9.5CM H

ITEM NO: 477756
15PC WATCH BOX
 BLACK
 33CM L X 32.5CM W X 9.5CM H

VICEROY



View your collection in a timeless Viceroy watch box. A modern classic that exudes an understated elegance. Choose from 8 piece, 10 piece with storage draw option and 15 piece boxes, taking care of your watch with effortless style.



EU RETAIL: €455.00



EU RETAIL: €495.00



EU RETAIL: €529.00



EU RETAIL: €679.00

ITEM NO: 466102
10PC WATCH BOX
 BLACK
 33CM L X 23CM W X 9.5CM H

ITEM NO: 466202
10PC WATCH BOX WITH DRAWER
 BLACK
 33CM L X 23CM W X 14CM H

ITEM NO: 466002
8PC WATCH BOX
 BLACK
 27CM L X 23CM W X 9.5CM H

ITEM NO: 466302
15PC WATCH BOX
 BLACK
 33CM L X 32.5CM W X 9.5CM H



JEWELLERY BOXES

WOLF's refined jewellery cases combine the finest materials with over five generations of handmade tradition. Interiors treated with patented LusterLoc™ and compartments designed for every piece in your collection keep your jewellery sparkling and ready to wear. With many styles and finishes to choose from WOLF safely stores your jewellery at home or on the go. From embroidered florals to classic leathers WOLF offers the perfect jewellery box for everyone.

CAROLINE



The embodiment of sophistication and style. Caroline, a timeless classic with elegant soft lines of the 50's, supple diamond quilted leather accented with gold hardware. A refined case and home for your precious jewellery and heirlooms. Choose from classic ivory to chic black. Your style, your jewellery box.



EU RETAIL: €415.00



EU RETAIL: €615.00



EU RETAIL: €1,035.00

ITEM NO: 3297

MEDIUM JEWELLERY BOX

RED / BLACK / IVORY

28.2CM L X 22CM W X 18CM H



RED
72



BLACK
71



IVORY
53

ITEM NO: 3296

LARGE JEWELLERY BOX

RED / BLACK / IVORY

32.4CM L X 22CM W X 24CM H

ITEM NO: 3295

EXTRA LARGE JEWELLERY BOX

RED / BLACK / IVORY

42CM L X 28.1CM W X 30.4CM H

PALERMO



Sophistication must be effortless. Charm and style has to come with ease. Palermo takes cues from its namesake city on the side of a mountain by the sea. Sumptuous leathers in traditional colours with flair, pewter, black anthracite and rose gold sparkle and the Ferrari red tempts. Your jewellery deserves a classic home.



EU RETAIL: €169.00



EU RETAIL: €339.00



EU RETAIL: €759.00

ITEM NO: 2135

SAFE DEPOSIT BOX

ROSE GOLD / BLACK ANTHRACITE / RED / PEWTER
27.9CM L X 11.9CM W X 4.7CM H



ROSE GOLD
16



BLACK
ANTHRACITE
02



RED
72



PEWTER
78

ITEM NO: 2132

MEDIUM JEWELLERY BOX

ROSE GOLD / BLACK ANTHRACITE / RED / PEWTER
30.6CM L X 21.8CM W X 7.7CM H

ITEM NO: 2130

LARGE JEWELLERY BOX

ROSE GOLD / BLACK ANTHRACITE / RED / PEWTER
29CM L X 22.25CM W X 19CM H

SOPHIA



Where classic meets contemporary, function meets fashion, Sophia is designed to protect charms and charm jewellery in style. Each handmade charm jewellery box is treated with our patented LusterLoc™ anti-tarnish lining to keep your jewellery collections from Pandora, Thomas Sabo and many others looking its best at all times.



EU RETAIL: €245.00



EU RETAIL: €289.00

ITEM NO: 3924

JEWELLERY BOX WITH WINDOW

JADE / FOREST GREEN / INDIGO

35.6CM L X 25.4CM W X 7CM H

ITEM NO: 3920

JEWELLERY BOX WITH DRAWERS

JADE / FOREST GREEN / INDIGO

30.6CM L X 21CM W X 14.6CM H



JADE
30



FOREST GREEN
12



INDIGO
17

VAULT



Create your own custom jewellery box with Vault's clean lines and classic design. The range of Vault stacking trays and inserts lets you decide how to organise your jewellery storage to care for your collections. Made from Vegan leather in stylish black, grey, or ivory, your jewellery will be protected from tarnishing for 35 years in Vault; every insert is lined with LusterLoc™ treated Ultrasuede.

1. SELECT A LID



VAULT
GLASS TRAY LID
ITEM NO: 435302
BLACK
EU RETAIL: €39.00
38CM L X 21.5CM W X 0.9CM H



VAULT
GLASS TRAY LID
ITEM NO: 435353
IVORY
EU RETAIL: €39.00
38CM L X 21.5CM W X 0.9CM H



VAULT
GLASS TRAY LID
ITEM NO: 435365
GREY
EU RETAIL: €39.00
38CM L X 21.5CM W X 0.9CM H



VAULT
TRAY LID
ITEM NO: 434902
BLACK
EU RETAIL: €39.00
37.8CM L X 21.5CM W X 3CM H



VAULT
TRAY LID
ITEM NO: 434953
IVORY
EU RETAIL: €39.00
37.8CM L X 21.5CM W X 3CM H



VAULT
TRAY LID
ITEM NO: 434965
GREY
EU RETAIL: €39.00
37.8CM L X 21.5CM W X 3CM H

2. SELECT TRAY



VAULT
1.5" TRAY
ITEM NO: 435102
BLACK
EU RETAIL: €49.00
37.8CM L X 21.5CM W X 4.2CM H



VAULT
1.5" TRAY
ITEM NO: 435153
IVORY
EU RETAIL: €49.00
37.8CM L X 21.5CM W X 4.2CM H



VAULT
1.5" TRAY
ITEM NO: 435165
GREY
EU RETAIL: €49.00
37.8CM L X 21.5CM W X 4.2CM H



VAULT
2" TRAY
ITEM NO: 435002
BLACK
EU RETAIL: €55.00
37.9CM L X 21.5CM W X 5.5CM H



VAULT
2" TRAY
ITEM NO: 435053
IVORY
EU RETAIL: €55.00
37.9CM L X 21.5CM W X 5.5CM H



VAULT
2" TRAY
ITEM NO: 435065
GREY
EU RETAIL: €55.00
37.9CM L X 21.5CM W X 5.5CM H



VAULT
4" TRAY
ITEM NO: 435202
BLACK
EU RETAIL: €65.00
38CM L X 21.5CM W X 10.5CM H



VAULT
4" TRAY
ITEM NO: 435253
IVORY
EU RETAIL: €65.00
38CM L X 21.5CM W X 10.5CM H



VAULT
4" TRAY
ITEM NO: 435265
GREY
EU RETAIL: €65.00
38CM L X 21.5CM W X 10.5CM H

VAULT

3. SELECT INSERTS



EU RETAIL: €45.00



EU RETAIL: €45.00



EU RETAIL: €45.00



EU RETAIL: €65.00



EU RETAIL: €45.00



EU RETAIL: €45.00



EU RETAIL: €115.00



EU RETAIL: €49.00



EU RETAIL: €55.00



EU RETAIL: €65.00

ITEM NO: 435670

EARRING INSERT

36.3CM L X 19.8CM W X 2.2CM H

ITEM NO: 435870

RING INSERT

36.3CM L X 19.8CM W X 2.8CM H

ITEM NO: 436670

WATCH STRAP INSERT

36.4CM L X 19.8CM W X 2.8CM H

ITEM NO: 435770

NECKLACE INSERT

36.3CM L X 19.8CM W X 2.2CM H

ITEM NO: 435570

BRACELET INSERT

36.3CM L X 19.8CM W X 2.2CM H

ITEM NO: 436770

SUNGLASS INSERT

36.2CM L X 19.7CM W X 5.72CM H

ITEM NO: 436570

WATCH INSERT

36.2CM L X 19.7CM W X 5.72CM H

ITEM NO: 4351

1.5" STANDARD TRAY

37.8CM L X 21.5CM W X 4.2CM H

ITEM NO: 4350

2" DEEP TRAY

37.9CM L X 21.5CM W X 5.5CM H

ITEM NO: 4352

4" DEEP TRAY

38CM L X 21.5CM W X 10.5CM H



EU RETAIL: €39.00



EU RETAIL: €39.00



EU RETAIL: €39.00



EU RETAIL: €39.00

ITEM NO: 437870

**EARRING MULTI-COMPARTMENT
HALF INSERT**

18.09CM L X 19.68CM W X 2.54CM H

ITEM NO: 437670

NECKLACE HALF INSERT

18.09CM L X 19.68CM W X 2.54CM H

ITEM NO: 437770

**RING MULTI-COMPARTMENT
HALF INSERT**

18.09CM L X 19.68CM W X 2.54CM H

ITEM NO: 437570

BRACELET HALF INSERT

18.09CM L X 19.68CM W X 2.54CM H

VAULT



IVORY



STANDARD LID
ITEM NO: 434953



GREY



GLASS LID
ITEM NO: 435365



BLACK



GLASS LID
ITEM NO: 435302



1" INSERT TRAY - RING
ITEM NO: 435870



.75" BRACELET INSERT
ITEM NO: 435570



.75" INSERT - NECKLACE
ITEM NO: 435770



.75" INSERT TRAY - EARRING
ITEM NO: 435670



2.25" SUNGLASSES INSERT
ITEM NO: 436770



1.5" VAULT TRAY
ITEM NO: 435102



2" VAULT TRAY
ITEM NO: 435053



4" VAULT TRAY
ITEM NO: 435265

1. SELECT A LID

2. SELECT A TRAY

3. SELECT INSERTS

1.5" STANDARD VAULT TRAY

INSERT OPTION SHOWN

1.) 1 X .75" INSERT

2" DEEP VAULT TRAY

INSERT OPTION SHOWN

1.) 1 X 1" INSERT & .75" INSERT

4" DEEP VAULT TRAY

INSERT OPTION SHOWN

1.) 1 X SUNGLASS INSERT & 1 X .75" INSERT

ZOE



Fresh faced and fun, Zoe is sophisticated but playful. Indigo or forest green velvet, highly embroidered with classic floral designs. A trend that is here to stay whilst at home or on the go.



EU RETAIL: €549.00



EU RETAIL: €775.00

ITEM NO: 3931

MEDIUM JEWELLERY BOX

FOREST GREEN / INDIGO

28.9CM L X 23CM W X 21CM H

ITEM NO: 3930

LARGE JEWELLERY BOX

FOREST GREEN / INDIGO

33.6CM L X 23.5CM W X 23.5CM H



FOREST GREEN

12



INDIGO

16



TRAVEL CASES

WOLF's jewellery travel cases are the perfect solution to keep your jewellery safe and ready to wear while you are on your travels. Every case interior is treated with our patented LusterLoc™ and with many sizes, styles and finishes to choose from you will be spoilt for choice. WOLF simply offers the perfect jewellery travel cases for everyone.

CAROLINE



The embodiment of sophistication and style. Caroline, a timeless classic with elegant soft lines of the 50's, supple diamond quilted leather accented with gold hardware. Travel with Caroline makes safekeeping your jewellery whilst on the go a snap. Choose from the small zip travel case or jewellery portfolios, available in Ferrari red, black, or ivory. Your style your case.



EU RETAIL: €135.00



EU RETAIL: €189.00



EU RETAIL: €225.00

ITEM NO: 3299

ZIP TRAVEL CASE

RED / BLACK / IVORY

12CM L X 13.2CM W X 6CM H



RED
72



BLACK
71



IVORY
53

ITEM NO: 3248

JEWELLERY PORTFOLIO

RED / BLACK / IVORY

22.4CM L X 13CM W X 3CM H

ITEM NO: 3240

LARGE JEWELLERY PORTFOLIO

RED / BLACK / IVORY

16.5CM L X 27.5CM W X 3.2CM H

MARIA



A new classic is born with Maria. Pure sophistication with clean lines and just the right amount of detail. Maria is inspired by and for the traveller in love with cities they've never been to and people they've never met. Our first complete travel collection wrapped in rich smooth leathers and stunning gold accents. Maria is perfect for keeping jewellery in place with style; for business, leisure and everything in between.



EU RETAIL: €169.00



EU RETAIL: €145.00



EU RETAIL: €179.00



EU RETAIL: €255.00



EU RETAIL: €279.00

ITEM NO: 7665

ZIP JEWELLERY CUBE

NAVY / WHITE / MUSTARD / TANGERINE
11.4CM L X 11.4CM W X 7.6CM H

ITEM NO: 7662

SMALL ZIP CASE

NAVY / WHITE / MUSTARD / TANGERINE
12CM L X 12.5CM W X 6.2CM H

ITEM NO: 7664

JEWELLERY PORTFOLIO

NAVY / WHITE / MUSTARD / TANGERINE
23CM L X 13.3CM W X 3.3CM H

ITEM NO: 7663

MEDIUM ZIP CASE

NAVY / WHITE / MUSTARD / TANGERINE
21CM L X 13.5CM W X 6.8CM H



NAVY
17



WHITE
53



MUSTARD
93



TANGERINE
39

ITEM NO: 7661

LARGE ZIP CASE

NAVY / WHITE / MUSTARD / TANGERINE
26CM L X 20CM W X 6.4CM H

PALERMO



Sophistication must be effortless. Charm and style has to come with ease. Palermo takes cues from its namesake city on the side of a mountain by the sea. Sumptuous leathers in traditional colours with flair, pewter, black anthracite and rose gold sparkle and the Ferrari red tempts. Your jewellery and watches deserve a classic home.



EU RETAIL: €279.00



EU RETAIL: €225.00



EU RETAIL: €185.00

ITEM NO: 2139

DOUBLE WATCH ROLL + JEWELLERY CASE

PEWTER / BLACK ANTHRACITE / RED / ROSE GOLD
20.5CM L X 8CM W X 9CM H



PEWTER

78



BLACK
ANTHRACITE

02



RED

72



ROSE GOLD

16

ITEM NO: 2134

JEWELLERY ROLL

PEWTER / BLACK ANTHRACITE / RED / ROSE GOLD
23.5CM L X 10.4CM W X 3.5CM H

ITEM NO: 2136

ZIP CASE

PEWTER / BLACK ANTHRACITE / RED / ROSE GOLD
17CM L X 12.5CM W X 5.7CM H

SOPHIA



Where classic meets contemporary, function meets fashion, Sophia is designed to protect charms and charm jewellery in style. Each handmade charm jewellery box is treated with our patented LusterLoc™ anti-tarnish lining to keep your jewellery collections from Pandora, Thomas Sabo and many others looking its best at all times.



EU RETAIL: €95.00



EU RETAIL: €145.00

ITEM NO: 3923

ROUND ZIP CASE

JADE / FOREST GREEN / INDIGO

12CM L X 12.7CM W X 6CM H

ITEM NO: 3922

TRAVEL ZIP CASE

JADE / FOREST GREEN / INDIGO

18CM L X 12.7CM W X 6.6CM H



JADE
30



FOREST GREEN
12



INDIGO
17

ZOE



Fresh faced and fun, Zoe is sophisticated but playful. Indigo or forest green velvet, highly embroidered with classic floral designs. A trend that is here to stay. Choose from our travel round, zip case or portfolio and travel in style for your next holiday.



EU RETAIL: €129.00



EU RETAIL: €205.00



EU RETAIL: €209.00

ITEM NO: 3932

TRAVEL ROUND ZIP CASE

FOREST GREEN / INDIGO

12CM L X 12CM W X 6CM H



FOREST GREEN

12



INDIGO

16

ITEM NO: 3933

TRAVEL ZIP CASE

FOREST GREEN / INDIGO

20CM L X 12.8CM W X 5.9CM H

ITEM NO: 3934

JEWELLERY PORTFOLIO

FOREST GREEN / INDIGO

27CM L X 18.8CM W X 4CM H



SAFES

The 1834 Safe Collection is the next level of WOLF's commitment to protecting your most precious valuables. Our meticulously crafted safes are made to provide the ultimate in security while upholding WOLF's iconic design identity of melding beauty and functionality. In addition to our standard collection we offer a completely bespoke experience that allows you to choose leather, hardware colour, and interior configurations, ensuring that your taste is matched perfectly.





ATLAS



Designed with beauty and function in mind the Atlas is forged in American steel, UL tested and certified for burglary & fire. Available in two stunning high gloss finishes of onyx or titanium and lined with LusterLoc™ to stop jewellery from tarnishing for up to 35 years. Choose from 4 to 20 winder modules (in groups of 4) to ensure that your collection keeps perfect time. Atlas is the solution for the protection of your most precious valuables.



EU RETAIL: €27,435.00

EU RETAIL: €27,435.00

EU RETAIL: €31,459.00

EU RETAIL: €31,459.00



EU RETAIL: €35,475.00

EU RETAIL: €35,475.00

EU RETAIL: €39,495.00

EU RETAIL: €39,495.00



EU RETAIL: €43,515.00

EU RETAIL: €43,515.00

EU RETAIL: €25,585.00

EU RETAIL: €25,585.00



ONYX
64



TITANIUM
65

ITEM NO: 4904

4 PIECE WINDER SAFE

ONYX / TITANIUM

55.9CM L X 61CM W X 101.6CM H

ITEM NO: 4912

12 PIECE WINDER SAFE

ONYX / TITANIUM

55.9CM L X 61CM W X 101.6CM H

ITEM NO: 4920

20 PIECE WINDER SAFE

ONYX / TITANIUM

55.9CM L X 61CM W X 101.6CM H

ITEM NO: 4918

8 PIECE WINDER SAFE

ONYX / TITANIUM

55.9CM L X 61CM W X 101.6CM H

ITEM NO: 4916

16 PIECE WINDER SAFE

ONYX / TITANIUM

55.9CM L X 61CM W X 101.6CM H

ITEM NO: 4900

JEWELLERY SAFE

ONYX / TITANIUM

55.9CM L X 61CM W X 101.6CM H

STYLES & FEATURES

HIGH-GLOSS FINISHES

Atlas is available in both finishes.



ONYX
Matte Black Interior 64



TITANIUM
Matte Black Interior 65

ATLAS

Weight: 331 kgs

Dimensions:
55.9W x 61D x 101.6H cm

Customisable to meet your needs. Select the number of winding modules, drawers and drawer configurations.

For more information go to WOLF1834.com and customise your Atlas today!

FEATURES

- Store watches, jewellery, documents, etc.
- UL certified independent testing
- Bluetooth user-controlled app
- Rotation Options: 1-1,999 turns per day
- Directional Settings: clockwise, counter clockwise, or bi-directional
- Start Delay: Up to 255-hour delay
- Patented lock-in cuff design
- Custom 1834 grey LusterLoc™ treated ultrasuede interior



UL CERTIFIED INDEPENDENT TESTING

Verified Fire Resistance:

- For up to 120 minutes, tested at 927°C, then dropped from 30 feet.
- The interior temperature during the fire test remains below 177°C, (paper burns at 232°C, so your documents remain safe.

Verified Water Resistance:

- The interior of the safe door is sealed with Palusol® fire seal which expands 8 times the original size, sealing the door.



BLUETOOTH USER-CONTROLLED APP

- Effortlessly control winder modules either independently or simultaneously with WOLF app (download on the App Store or get it on Google Play).
- Customise your safe with the ability to name the safe and each winder.
- Upload your watches or personal photos as background image.
- i-Mode feature controls LED light with the ability to set on/off timers based on your schedule.
- Password-protected app control.
- Register your warranty from your phone.
- Contact customer service and shop online.

CHURCHILL

There is no limit to what we can craft for you. We begin with the size and configuration of the interior of the safe. You choose how many WOLF Bluetooth app controlled watch winders and the number of drawers for watches, jewellery or other valuables. We will then assist you in selecting the exterior for your safe, either sumptuous leathers or beautifully polished hardwoods. For more information and to start your Churchill design project visit www.wolf1834.com/churchill-safes



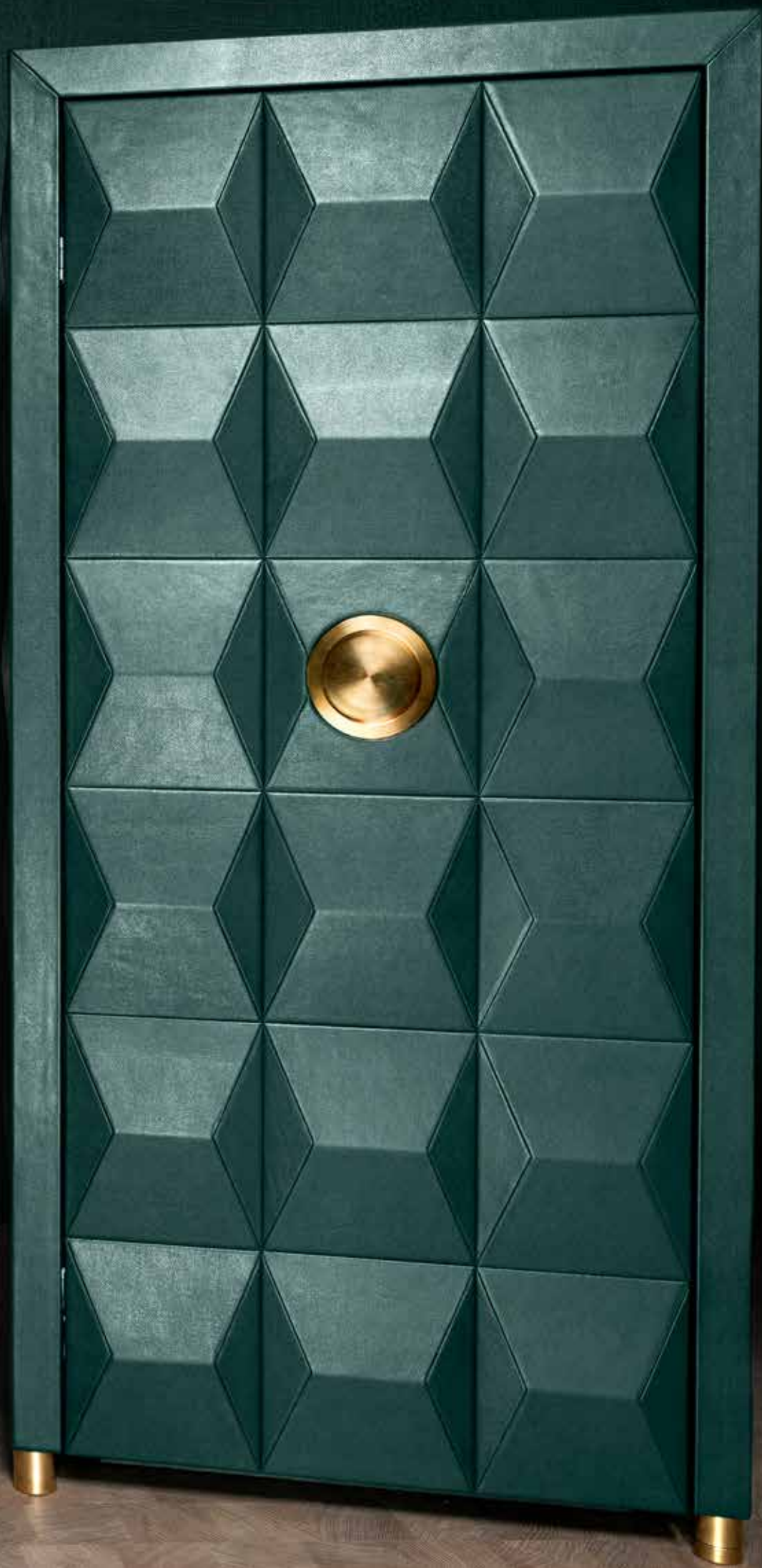



EU RETAIL STARTING AT €123,195.00

CHURCHILL 16 PIECE WINDER SAFE
BRITISH RACING GREEN

CHURCHILL

Experience the world of bespoke safes with Churchill.

The Churchill is a custom safe crafted by the artisans

at WOLF and made for you. Select the leather,

hardware colour and interior configurations of

drawers and winders to ensure you bring home

a piece as unique as you. For more information

contact www.wolf1834.com/contact

Starting retail price €113,295.00

WOODS AND LEATHERS
AVAILABLE IN YOUR CHOICE OF
TEXTURE AND COLOUR





CHOOSE HOW MANY BLUETOOTH APP CONTROLLED WATCH WINDERS AND THE NUMBER OF DRAWERS FOR WATCHES, JEWELLERY OR OTHER VALUABLES.





SECURITY

Forged Steel Plates

9 Independent Bolts

Sargent and Greenleaf Keypads

STYLES & FEATURES

CHURCHILL

FEATURES

- Bluetooth user-controlled app
- Rotation Options: 1-1,999 turns per day
- Directional Settings: clockwise, counter clockwise, or bi-directional
- Start Delay: Up to 255-hour delay
- Return to start
- Patented lock-in cuff design
- 10 additional watch storage
- Luxurious nubuck leather interior
- Exceeds standards for S1 - S2 NH rating awarded by insurance companies

BLUETOOTH USER-CONTROLLED APP

- Effortlessly control winder modules either independently or simultaneously with WOLF app (download on the App Store or get it on Google Play).
- Customise your safe with the ability to name the safe and each winder.
- Upload your watches or personal photos as background image.
- i-Mode feature controls LED light with the ability to set on/off timers based on your schedule.
- Password-protected app control.
- Register your warranty from your phone.
- Contact customer service and shop online.



BRITISH RACING GREEN

Leather wrapped: safe

Wood encased: cabinet

Dimensions:

78W x 56D x 167H cm

16 PIECE



PEBBLE

Leather wrapped: safe

Wood encased: cabinet

Dimensions:

74W x 54D x 165H cm

16 PIECE



MACASSAR

Leather wrapped: safe

Wood encased: cabinet

Dimensions:

74W x 54D x 165H cm

24 PIECE





SMALL LEATHER GOODS

WOLF's range of luxury accessories for men and women includes wallets and billfolds, travel accessories, tech cases and bags. All designed innovatively to provide protection for your precious items with RFID in wallets and clever detailing for your travels. Classic beautiful design made from the finest leather alongside innovative sustainable materials made from apple pulp and recycled plastic bottles, luxury with a conscience.

MIMI



Mimi is for the woman on the go who needs her essentials close but wants to be free of bulky handbags. Inspired by both high runway fashion moments of the 90's and ancient Japanese Sagemonos, Mimi helps you travel light so you can go about your day in style.



EU RETAIL: €75.00



EU RETAIL: €135.00



EU RETAIL: €155.00



EU RETAIL: €135.00

ITEM NO: 7682

CREDIT CARD HOLDER WITH WRISTLET

MARINE / FOREST GREEN / RED / PINK / BLACK
10.5CM L X 8CM W X 2CM H

ITEM NO: 7684

MINI BAG WITH WRISTLET AND LANYARD

MARINE / FOREST GREEN / RED / PINK / BLACK
13CM L X 3.9CM W X 10.4CM H

ITEM NO: 7683

CROSSBODY BAG WITH WRISTLET AND LANYARD

MARINE / FOREST GREEN / RED / PINK / BLACK
18CM L X 4CM W X 11CM

ITEM NO: 7685

PHONE CASE WITH WRISTLET AND LANYARD

MARINE / FOREST GREEN / RED / PINK / BLACK
9.5CM L X 17.1CM W X 1.9CM H



MARINE
24

FOREST GREEN
12

RED
72

PINK
90

BLACK
02

MIMI





EU RETAIL: €85.00



UEU RETAIL: €125.00



EU RETAIL: €165.00



EU RETAIL: €339.00

ITEM NO: 7689

LUGGAGE TAG

MARINE / FOREST GREEN / RED / PINK / BLACK
6.35CM L X 0.63CM W X 10.9CM H

ITEM NO: 7688

PASSPORT SLEEVE

MARINE / FOREST GREEN / RED / PINK / BLACK
9.9CM L X 1.9CM W X 13.97CM H

ITEM NO: 7687

CONTINENTAL WALLET

MARINE / FOREST GREEN / RED / PINK / BLACK
20.3CM L X 1.9CM W X 8.9CM H

ITEM NO: 7686

13" LAPTOP ZIP + HANDLE

MARINE / FOREST GREEN / RED / PINK / BLACK
33CM L X 5.08CM W X 24.13CM H



MARINE
24

FOREST GREEN
12

RED
72

PINK
90

BLACK
02

SIGNATURE



The Signature Collection is designed for the world traveller who cares about the planet that they travel around. The collection is vegan, 95% sustainable and is made from recycled materials including apple pulp and plastic bottles. Inspired by vintage luggage, the collection is made with a fully recycled plastic exterior. The collection features wallets, card cases, travel accessories and laptop cases, all finished with a monogram pattern, gold hardware and has a RFID protection lining to ensure personal data is protected.

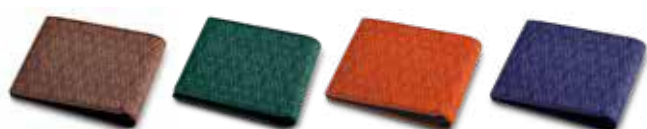

EU RETAIL: €79.00



EU RETAIL: €79.00

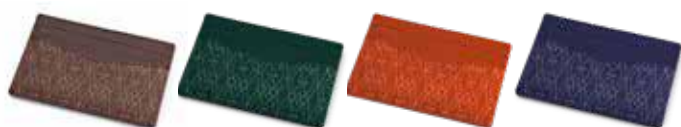

EU RETAIL: €59.00

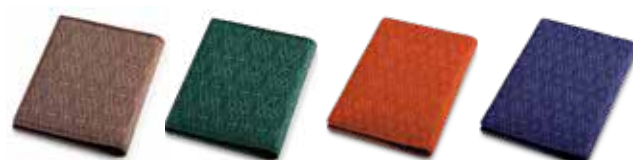

EU RETAIL: €65.00



EU RETAIL: €109.00



EU RETAIL: €79.00

ITEM NO: 7760

BILFOLDBROWN / GREEN / ORANGE / BLUE
11CM L X 0.12CM W X 1CM H

ITEM NO: 7761

BILFOLD AND COINBROWN / GREEN / ORANGE / BLUE
11CM L X 9CM W X 1CM H

ITEM NO: 7762

CARDHOLDERBROWN / GREEN / ORANGE / BLUE
10CM L X 7CM W X 1CM H

ITEM NO: 7763

ID CARD CASEBROWN / GREEN / ORANGE / BLUE
8CM L X 10CM W X 1CM H

ITEM NO: 7764

ZIP WALLETBROWN / GREEN / ORANGE / BLUE
10.7CM L X 9CM W X 2CM H

ITEM NO: 7765

ZIP CARD CASEBROWN / GREEN / ORANGE / BLUE
14CM L X 8CM W X 1CM H

BROWN

33



GREEN

30



ORANGE

39



BLUE

24

SIGNATURE





EU RETAIL: €65.00



EU RETAIL: €269.00

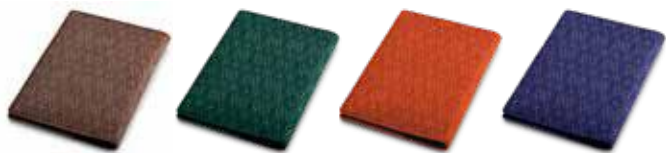

EU RETAIL: €69.00



EU RETAIL: €189.00



EU RETAIL: €115.00



EU RETAIL: €119.00

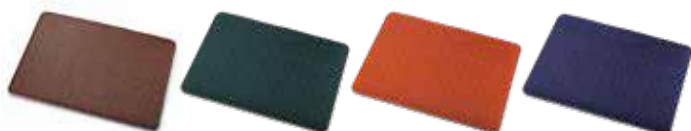

EU RETAIL: €119.00



EU RETAIL: €159.00

ITEM NO: 7767

LUGGAGE TAGBROWN / GREEN / ORANGE / BLUE
8CM L X 12CM W X 1CM H

ITEM NO: 7766

PASSPORT SLEEVEBROWN / GREEN / ORANGE / BLUE
10CM L X 14CM W X 1CM H

ITEM NO: 7770

13" LAPTOP SLEEVEBROWN / GREEN / ORANGE / BLUE
32CM L X 22CM W X 1CM H

ITEM NO: 7771

16" LAPTOP SLEEVEBROWN / GREEN / ORANGE / BLUE
34CM L X 24.5CM W X 1CM H

ITEM NO: 7768

TRAVEL CASEBROWN / GREEN / ORANGE / BLUE
11CM L X 25CM W X 2.5CM H

ITEM NO: 7769

IPAD TECH CASEBROWN / GREEN / ORANGE / BLUE
22CM L X 27CM W X 3CM H

ITEM NO: 7773

16" LAPTOP ZIP CASEBROWN / GREEN / ORANGE / BLUE
34CM L X 24.5CM W X 1CM H

ITEM NO: 7772

WASH BAGBROWN / GREEN / ORANGE / BLUE
25CM L X 14CM W X 11CM HBROWN
33GREEN
30ORANGE
39BLUE
24

W



The W Collection is a luxurious, sleek, and sophisticated leather accessories collection for the modern man. Crafted with embossed grain and sustainably sourced leather, our gold W logo and deep green lining. The collection includes wallets, business accessories and a wash bag all created with meticulous attention to detail and timeless, sophisticated design.



EU RETAIL: €99.00



EU RETAIL: €105.00



EU RETAIL: €65.00



EU RETAIL: €79.00



EU RETAIL: €119.00



EU RETAIL: €79.00



EU RETAIL: €209.00



EU RETAIL: €229.00

ITEM NO: 774202

CARDHOLDER

BLACK

10CM L X 7CM W X 1CM H

ITEM NO: 774402

GUSSET CARD CASE

BLACK

10CM L X 7CM W X 1CM H

ITEM NO: 774002

BILLFOLD WALLET

BLACK

11CM L X 9CM W X 1CM H

ITEM NO: 774302

ID CARD CASE

BLACK

8CM L X 10CM W X 1CM H

ITEM NO: 774602

LAPTOP SLEEVE

BLACK

33CM L X 24CM W X 2CM H

ITEM NO: 774102

BILLFOLD AND COIN WALLET

BLACK

11CM L X 9CM W X 1CM H

ITEM NO: 774502

MOULDED CARD

BLACK

7CM L X 8CM W X 2CM H

ITEM NO: 774702

WASH BAG

BLACK

25CM L X 15CM W X 12CM H



COLLABORATIONS

As the saying goes “a perfect match, made in heaven” and so it is with the utmost of consideration that we choose the company we keep. Our collaborations are rare and highly selective, Bea Bongiasca, Analog/Shift and WM Brown grace the following pages with innovative design twists that give a perfect nod to both brands.



ANALOG/SHIFT



Analog/Shift, leading retailer of vintage and contemporary timepieces based in New York City, have teamed up with WOLF, experts in watch care for over 185 years, to bring you beautiful modern interpretations of famous historical boxes with this limited edition collection.



EU RETAIL: €499.00



EU RETAIL: €149.00



EU RETAIL: €475.00



EU RETAIL: €439.00



EU RETAIL: €149.00



EU RETAIL: €499.00

ITEM NO: 708041

10 PIECE WATCH BOX

GREEN

32.7CM L X 22.9CM W X 10.16CM H

ITEM NO: 710211

5 PIECE WATCH BOX

NATURAL

36.5CM L X 12.7CM W X 8.3CM H

ITEM NO: 708141

STRAP CHANGING TRAY

GREEN

17.78CM L X 18.42CM W X 3.18CM H

ITEM NO: 709361

STRAP CHANGING TRAY

CORK

17.78CM L X 18.42CM W X 3.18CM H

ITEM NO: 710212

5 PC WATCH BOX

WALNUT

36.5CM L X 12.7CM W X 8.3CM H

ITEM NO: 709261

8 PC WATCH BOX

CORK

26.04CM L X 22.23CM W X 10.16CM H



GREEN

41



WALNUT

12



SHIFT CORK

61



SHIFT WOOD

11

BEA BONGIASCA



WOLF continues to revolutionise the art of crafting boxes in this collaboration with innovative jewellery designer Bea Bongiasca. Inspired by seventies swagger, the collection consists of jewellery boxes, jewellery trays with lids and travel-ready mini jewellery cases and even a safe, all in eye-popping colour combinations and kaleidoscopic patterns.



EU RETAIL: €145.00



EU RETAIL: €115.00



EU RETAIL: €269.00



EU RETAIL: €425.00



EU RETAIL: €49,095.00



EU RETAIL: €685.00

ITEM NO: 882001 / 882002 / 882003

SMALL JEWELLERY BOX

YELLOW BLUE PURPLE / BLUE PINK YELLOW /
PINK GREEN BLUE

9.5CM L X 6.3CM W X 7CM H

ITEM NO: 882004 / 882005 / 882006

SMALL JEWELLERY TRAY

RED BLUE / GREEN PURPLE / PINK YELLOW

15CM L X 12.5CM W X 3CM H

ITEM NO: 882012 / 882011 / 882010

MEDIUM JEWELLERY TRAY

BLUE PINK YELLOW / GREEN PURPLE BLUE /
RED BLUE PURPLE

30CM L X 17CM W X 4CM H

ITEM NO: 882007 / 882008

MEDIUM JEWELLERY BOX

PINK RED BLUE / GREEN PINK YELLOW

25CM L X 15CM W X 8CM H

ITEM NO: 490471

BEA ATLAS SAFE

BLUE

55.9CM L X 61CM W X 101.6CM H

ITEM NO: 882009

LARGE JEWELLERY BOX

GREEN PINK YELLOW

32CM L X 17CM W X 12.5CM H

WM BROWN



Known for his impeccable taste in fashion and love of watches Matt Hranek founder and editor of WM Brown has partnered with WOLF to craft a collection of products made for the modern man. The collection features WOLF's signature watch winders, watch boxes, and watch rolls or why not indulge in the ultimate gentlemen's accessory, the WM Brown Drinks Safe, all infused with WM Brown's iconic Negrone Tweed. Negrone Tweed was created in an English wool mill by the Fox Brothers for Matt & WM Brown in celebration of the delicious Negroni cocktail.



EU RETAIL: €49,095.00



EU RETAIL: €305.00



EU RETAIL: €485.00



EU RETAIL: €445.00



EU RETAIL: €105.00



EU RETAIL: €555.00



EU RETAIL: €385.00



EU RETAIL: €179.00



EU RETAIL: €109.00

ITEM NO: 490406

WM BROWN ATLAS SAFE

BROWN

55.9CM L X 61CM W X 101.6CM H

ITEM NO: 800672

5 PIECE WATCH BOX

BROWN

36.51CM L X 12.7CM W X 8.26CM H

ITEM NO: 800688

SHOE SHINE CASE

BROWN

27CM L X 21.5CM W X 9CM H

ITEM NO: 800685

TRIPLE WATCH ROLL W/ CIGAR

BROWN

19.69CM L X 8.89CM W X 8.89CM H

ITEM NO: 800687

SET OF 4 COASTERS

BROWN

9.91CM L X 9.91CM W X 3.18CM H

ITEM NO: 800689

NEGRONI ASTUCCIO BEVERAGE

BROWN

8.8CM L X 8.8CM W X 16.3CM H

ITEM NO: 800670

SINGLE WINDER

BROWN

13.33CM L X 15.24CM W X 14.6CM H

ITEM NO: 800686

HUMIDOR

BROWN

27.3CM L X 23.5CM W X 8.26CM H

ITEM NO: 800692

SNAP COIN / VALET TRAY

BROWN

23CM L X 23CM W X 4CM H

PROTECT YOUR LEGACY

WOLF1834.COM

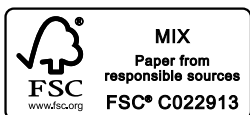

Printed by a UK CarbonNeutral® company. Manufacturing mill and printer registered to the Environmental Management System ISO14001 & Forest Stewardship Council® (FSC®) chain-of-custody certified.