



**CATALOGUE DE TRAVAIL
RETAIL CATALOG**

2023

La vie est Aventures



SOMMAIRE

CONTENT

COLLECTION GF300	4-23
COLLECTION GF38	24-33
COLLECTION GF3000	34-41
MAROQUINERIE HORLOGÈRE	
WATCH LEATHER GOODS	42-43
BRACELETS STRAPS	
• Coffret Box	44-45
• Métal & cuir «anses droites» Metal bands & leather straps “straight ends”	46
• Cuir «anses droites» Leather «straight ends»	47
• Nato Nato	48-51
• Caoutchouc EPDM EPDM rubber	52-53
• Caoutchouc FKM FKM rubber	54-55
• Kit : cuir «anses découpées» Leather straps kit : «cut edges»	56
• Cuir «anses découpées» Leather straps «cut edges»	57
ANSES ENDS	58
BOUCLES BUCKLES	59
KIT RÉPARATION REPAIR KIT	60-61
PIÈCES DÉTACHÉES SPARE PARTS	
• GF300	62-83
• GF38	84-89
• GF3000	90-99
• Bracelet métal Metal band V1	100-101
• Bracelet métal Metal band V2	102-103
• Bracelet métal Metal band GF38	104-105
OUTILS MARKETING	
MARKETING TOOLS	106-107
PLV DISPLAY	108-111
ACCESOIRES ACCESSORIES	112-113
TARIF RÉPARATIONS REPAIR TARIFF	114
GRILLE DE MISE À TAILLE	
SIZING INFORMATION	115



4.

GRANDS FONDS 300



BREVET & EXCLUSIVITÉ

WORLD PATENT & EXCLUSIVITY

EASY CLEAN SYSTEM™

L'ECS™ Patent pending est une solution technique répondant à la problématique constatée par les plongeurs démineurs de la Marine Nationale au cours de leurs multiples plongées : le sel se cristallisait dans les espaces entre la lunette et le boîtier, bloquant ainsi sa rotation. Pour la réédition 2015 de la Grands Fonds 300, ZRC a mis au point et breveté (N°1462496) une solution fonctionnelle : L'ECS™ est né. Système unique de nettoyage de l'intérieur de la lunette par une circulation d'eau claire permettant la dilution et l'évacuation du sel de mer. L'ECS™ est l'hommage ultime à la Grands Fonds 300 d'origine et s'inscrit clairement dans l'ADN de la marque.

The ECS™ is a technical solution to an issue encountered by the mine clearance diver's groups of the marine nationale during their many dives: Salt crystallizing in the gaps between the bezel and case, thus impeding its rotation. For the Grands Fonds 300 re-issue, ZRC developed and patented (No. 1462496) a functional solution: the ECS™ was born. A unique system for cleaning the inside of the bezel by circulating fresh water that dilutes and evacuates the sea salt, the ECS™ is the ultimate tribute to the original Grands Fonds and is perfectly in tune with the brand's identity.



CIRCUIT D'EAU DE L'ECS™
WATER CIRCUIT OF THE ECS™ :

- 1
Prise d'eau / Water intake
- 2
Nettoyage du crantage de la lunette
Cleaning the notches of the bezel
- 3
Nettoyage des espaces lunette/boîtier
Cleaning the space between the case and bezel

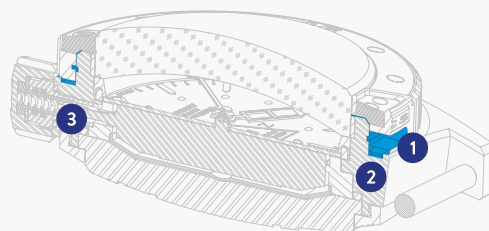

.5



CROWN PROTECTION SYSTEM™

100% de sécurité garantie grâce au système exclusif de bracelet à anses escamotables. La mise à l'eau sans avoir revissé la couronne en position initiale est impossible. Non revissée, elle empêche au bracelet de se remettre en place. Une méthode efficace pour parer les oublis à l'origine de désagréments technique.

100% safety is guaranteed thanks to this exclusive strap system using retractable lugs. It is now impossible to place the watch in water without screwing the crown back into its original position. If the crown is not screwed down, the strap cannot be correctly repositioned. This effective method prevents oversights that can lead to technical difficulties.



INDEX



Système exclusif **ECS™**
du nettoyage de la lunette
(brevet N° 1462492)

Exclusive bezel
cleaning system **ECS™**
(patent N° 1462492)



Système exclusif **CPS™**
de protection de la
couronne

Exclusiv **CPS™**
crown protection system



Profondeur 300 m
avec couronne vissée
30 ATM water resistance
with screwed crown



Verre saphir
3 ou 4 mm
3 or 4 mm
sapphire glass



Aiguilles SLN-X1
SLN-X1 hands



Date



Mouvement
automatique
Automatic
movement



Anti-magnétique
Amagnetic



Fabriqué en Suisse
Swiss made



Nickel free



Chrome free



Acier inoxydable
316L amagnétique
Nonmagnetic
316L Steel



Céramique
Ceramic



Synthétique
(bracelet Nato)
Synthetic
(Nato strap)



Caoutchouc
(EPDM/NDR)
Rubber
(EPDM/NDR)



Registration, Evaluation,
Authorisation and
Restriction of Chemicals



Restriction of the use
of certain **Hazardous**
Substances
in electrical and
electronic equipment



ISO 764 :
4800 A/m

6.



GRANDS FONDS 300

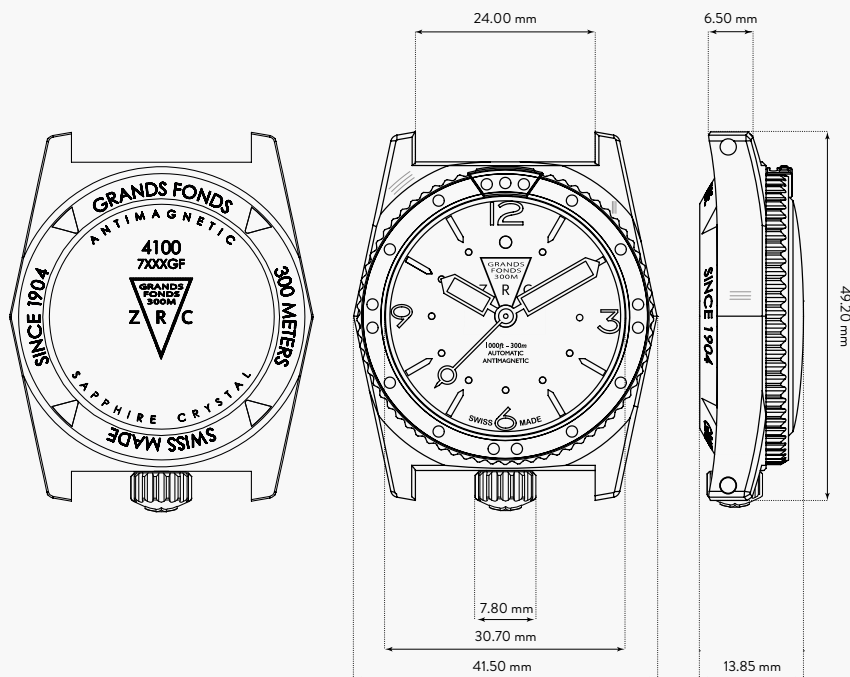

BOÎTIER / CASE

SPECIFICATION

Construction . Manufacture

Boîtier monobloc, fond et couronne vissés
Monobloc case screwed case back & crown

Diamètre . Diameter

41,5 mm

Matériaux . Materials

Acier inoxydable 316L amagnétique - Norme ISO764 : 4800 A/m
Nonmagnetic 316L Steel - ISO764 Standard: 4800 A/m

Lunette . Bezel

Système ECS™. Lunette tournante unidirectionnelle
crantée 60 divisions en titane avec insert en céramique
ECS™ system (Patent N°1462496). Unidirectional
60 divisions rotating titan bezel with ceramic insert

Couronne . Crown

Positionnée à 6H (Crown Protection System™)
Vissée double étanchéité à pas inversé
Located at 6H (Crown Protection System™)
Inverted screwed thread with dual sealing

Verre . Glass

Saphir bombé 3 mm . Sapphire 3 mm padded

Résistance à la pression
Pressure resistance

300 m

Profondeur testée . Tested depth

1500 m (151 bars)

MOUVEMENT / MOVEMENT

SPECIFICATION

Calibre . Calibre

SELLITA SW200-1 "Élaboré"
SELLITA "Elaborated" SW200-1

Réglage . Setting

+7sec/jour . +7sec/day

Amplitude . Amplitude

(± 7sec/jour) = de 0 à +14 sec/jour max
(± 7sec/day) = from 0 to 14 sec/day max

Remontage . Winding

Automatique . Automatic

Réserve de marche
Power reserve

38 h



GRANDS FONDS 300

LES DIFFÉRENTS MONTAGES THE DIFFERENT ASSEMBLING

TOUS LES MONTAGES
SONT COMPATIBLES

ALL ASSEMBLING
ARE COMPATIBLE

MONTAGE BRACELET ACIER METAL BAND ASSEMBLING (24x18 mm)

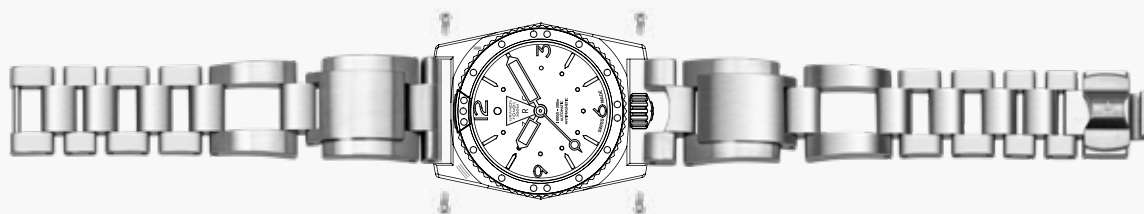

MONTAGE BRACELET CUIR "ANSES DÉCOUPÉES" OU "ANSES DROITES" "CUT EGES" OR "STRAIGHT ENDS" LEATHER STRAP ASSEMBLING (24x20 mm)

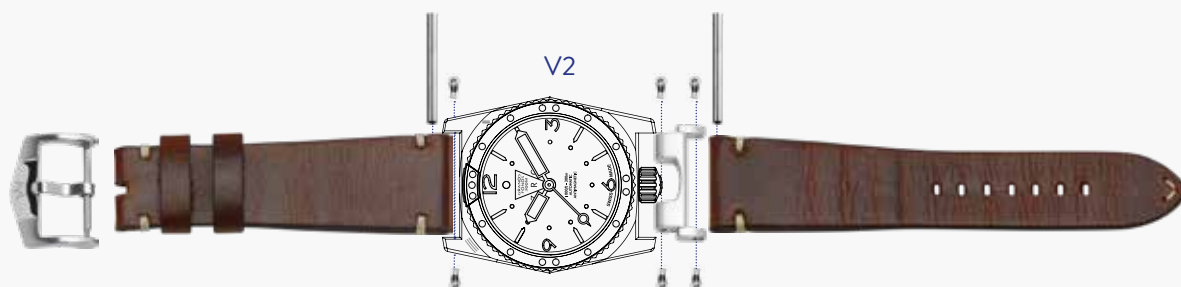

MONTAGE NATO STRAP
NATO STRAP ASSEMBLING
(24x24 mm)

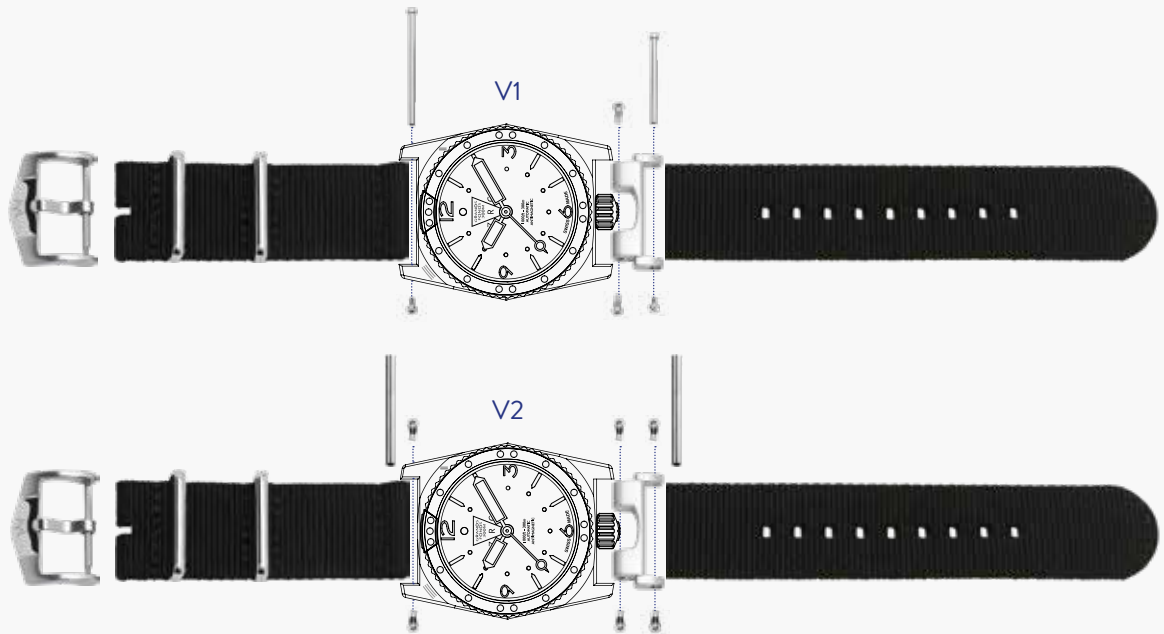

.9

MONTAGE BRACELET CAOUTCHOUC (EPDM)
RUBBER LEATHER STRAP ASSEMBLING
(24x20 mm)

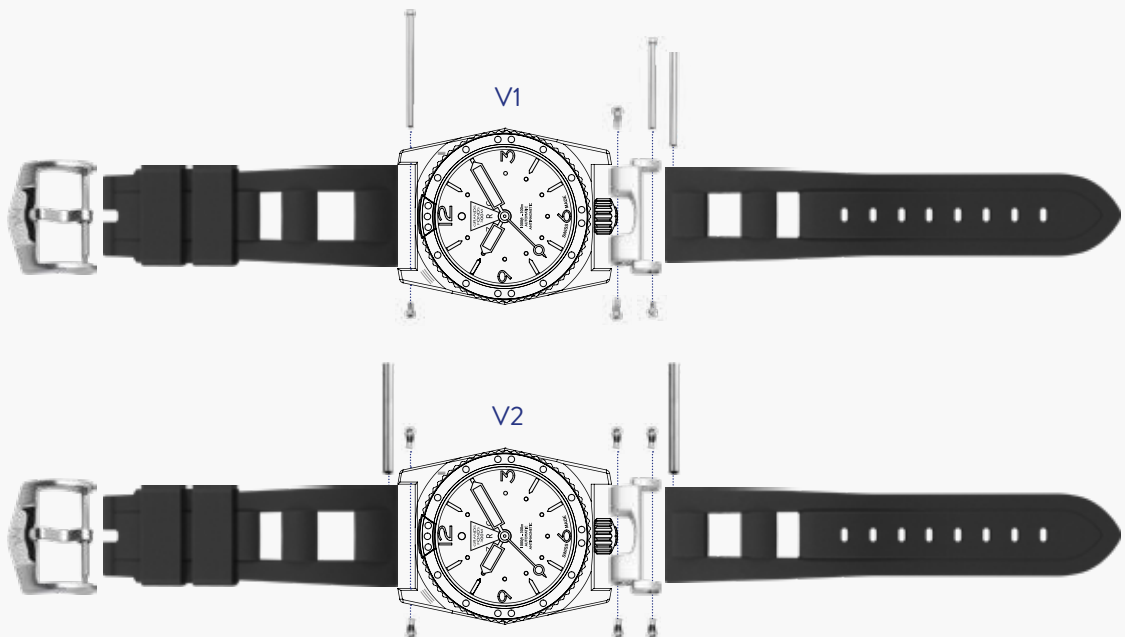



GRANDS FONDS 300 V1

IDENTIFICATION DES VIS DE BOÎTIER V1 (Boîtier 4000/4000E) CASE SCREWS IDENTIFICATION V1 (Case 4000/4000E)

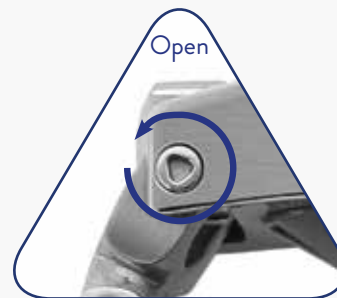

1/3
Devisser
Unscrew



REF : ZR70002



2/3
Appliquer la Loctite®
Add Loctite® glue

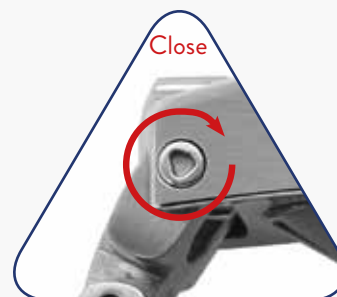

3/3
Visser
Screw

4000 & 4000E

Les séries 4000 et 4000E sont équipées des vis et embouts de tournevis V1 (plus fines).

The 4000 & 4000E series are equipped with V1 screws & screwdriver (Thinner).

10.



GRANDS FONDS 300 V2

IDENTIFICATION DES VIS DE BOÎTIER V2 (Boîtier 4000E2) CASE SCREWS IDENTIFICATION V2 (Case 4000E2)

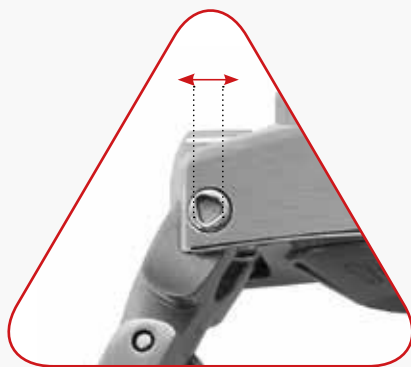

REF : ZR70027

4000E2

À partir de la série 4000E2 utiliser les vis
et embouts de tournevis V2 (plus larges et profondes).

From the serie 4000E2 use the V2 screws
& screwdrivers (larger & deeper).

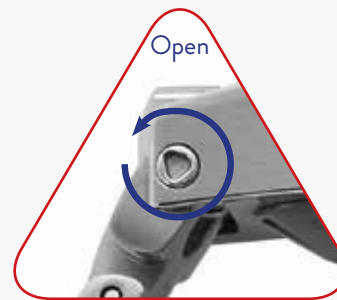

1/3
Devisser
Unscrew



2/3
Technologie Epotime
Epotime Technology

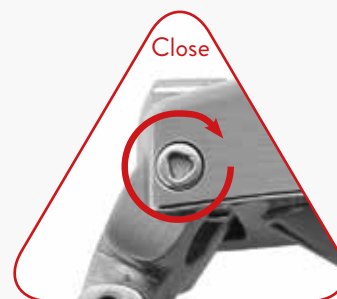

3/3
Visser
Screw



GRANDS FONDS 300 (MN64) 3000 (TITANIUM) - 38 (HERITAGE) V3

IDENTIFICATION DES VIS DE BOÎTIER V3 (Boîtier 4100) CASE SCREWS IDENTIFICATION V1 (CASE 4100)

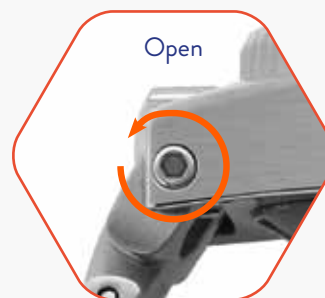

Open

1/3
Devisser
Unscrew



EPOTIME®

2/3
Technologie Epotime
Epotime Technology



4100

Les séries 4100 sont équipées des vis
et embouts de tournevis V3 (6 pans type ALLEN).

The 4100 series are equipped with
V3 screws & screwdriver (Allen type).

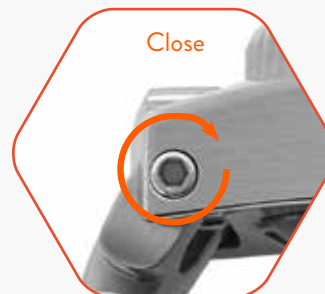

Close

3/3
Visser
Screw

12.



GRANDS FONDS 300

VIS ALLEN / ALLEN SCREW



.13

AVANTAGES

- UN OUTIL UNIQUE
- MEILLEURE PRECISION
- RESISTANCE ACCRUE
- MANIPULATION SIMPLIFIEE

BENEFITS

- A SINGLE TOOL
- BETTER ACCURACY
- ENHANCED RESISTANCE
- SIMPLIFIED HANDLING



GRANDS FONDS 300

MISE À TAILLE DU BRACELET ACIER (V3)

(V3) METAL BAND SIZING



Déjà équipé de demi maillons / Already equipped with 1/2 links

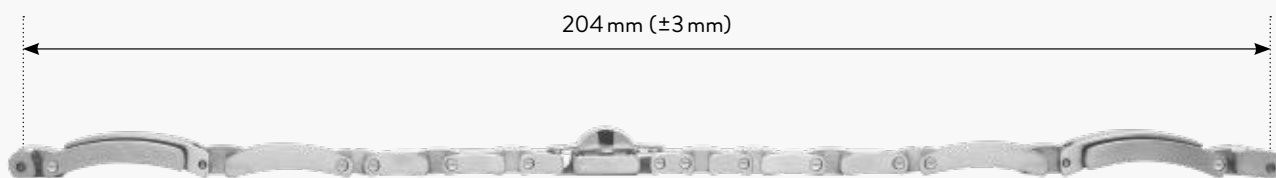

14.

Amplitude de réglage maximum de 115 à 191 mm
Sizing capacity from 115 to 191 mm





GRANDS FONDS 300

MONTAGE/DÉMONTAGE DU BRACELET ACIER (V3)
(V3) METAL BAND ASSEMBLING/DISASSEMBLING

1/2
Devisser
Unscrew

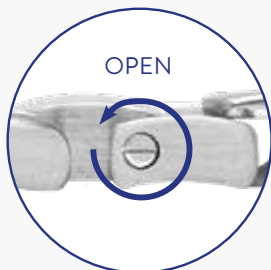

Revêtement
EPOTIME®
Coating



2/2
Visser
Screw

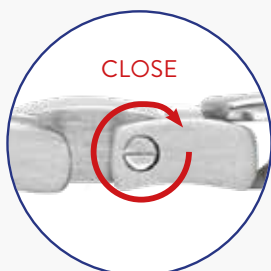



AMÉLIORATIONS PRODUIT

PRODUCT IMPROVEMENT

5



Ressort renforcé
Reinforced spring

4



Vis traitée Epotime®
Epotime screws

3



2



Fond en 2 parties :
• Une bague de serrage
• Un bloc de blindage

1



2021

16.

	2015	2021
Mouvement automatique Automatic movement	•	•
Boîtier acier anti-magnétique Amagnetic steel case	•	•
Verre saphir traité anti-reflet Anti-reflective sapphire crystal	•	•
Luminescence Super Luminova X1 SLN-X1 super luminous	•	•
Lunette avec insert céramique inrayable Scratchproof ceramic insert bezel		•
Maillon extensible renforcé ⁵ (nouveau ressort) Reinforced expansion link (new spring)		•
Nouvelles vis ALLEN de boîtier uniformisées ⁴ New uniformed ALLEN screws		•
Vis traitées Epotime à 100% 100% EPOTIME treated screws		•
Fond vissé avec alignement des gravures ¹ Screwed case back with aligned engravings		•
Couronne avec crantage amélioré Automatic movement		•
Augmentation du nombre de maillons et des combinaisons de réglage sur le bracelet métal ² Increase in the links quantity and adjustment combinaison for the metal band		•
Changement de bracelet optimisé Un seul tournevis suffit ³ Optimized metal band adjustment Only 1 screwdriver is required		•
Crantages de lunette améliorés Cranked bezel		•
Amélioration du boîtier, résistance à 1000m Global case improvement resist to 1000m		•



RÉÉDITION GF300 - MN64

1964 "FRENCH NAVY" REISSUE



18.



GF41178
BLACK PHANTOM DLC

3290,00



GF41168
RÉÉDITION MN64

2890,00

GRANDS FONDS 300



GF41163
RÉÉDITION MN64

3290,00

SELLITA SW200-1 "Elaboré". Réglage +7 sec (± 7 sec/jour) = de 0 à 14 sec/jour
SELLITA "Elaborated" SW200-1. Setting +7 sec (± 7 sec/day) = from 0 to 14 sec/day



RÉÉDITION GF300 - MN64

1964 "FRENCH NAVY" REISSUE



20.



GF41118
OSMIUM
2990,00



GF41199
TANGERINE
2990,00

GRANDS FONDS 300



GF41103
RUTHÉNIUM
2990,00



GF41198
FULL LUM
3290,00



GF41203
RÉÉDITION MN64
3590,00

SELLITA SW200-1 "Elaboré". Réglage +7 sec (± 7 sec/jour) = de 0 à 14 sec/jour
SELLITA "Elaborated" SW200-1. Setting +7 sec (± 7 sec/day) = from 0 to 14 sec/day



GF300 - 1964 SPIRIT



22.



GF41218
1964 SPIRIT
2990,00



GF41213
1964 SPIRIT
3590,00

GRANDS FONDS 300



GF40215
1964 SPIRIT
2890,00

SELLITA SW200-1 "Elaboré". Réglage +7 sec (\pm 7 sec/jour) = de 0 à 14 sec/jour
SELLITA "Elaborated" SW200-1. Setting +7 sec (\pm 7 sec/day) = from 0 to 14 sec/day



24.



GRANDS FONDOS 38 HERITAGE

.25



INDEX



Système exclusif **CPS™**
de protection de la
couronne
Exclusif **CPS™**
crown protection system



Profondeur 300 m
avec couronne vissée
30 ATM water resistance
with screwed crown



Verre saphir
2.4 mm
2.4 mm
sapphire glass



Aiguilles SLN-X1
SLN-X1 hands



Date



Mouvement
automatique
Automatic
movement



Anti-magnétique
Amagnetic



Fabriqué en Suisse
Swiss made



Nickel free



Chrome free



Acier inoxydable
316L amagnétique
Nonmagnetic
316L Steel



Céramique
Ceramic



Synthétique
(bracelet Nato)
Synthetic
(Nato strap)



Aluminium
Aluminum



Registration, Evaluation,
Authorisation and
Restriction of Chemicals



Restriction of the use
of certain **Hazardous**
Substances
in electrical and
electronic equipment



ISO 764 :
4800 A/m

26.



GRANDS FONDS 38

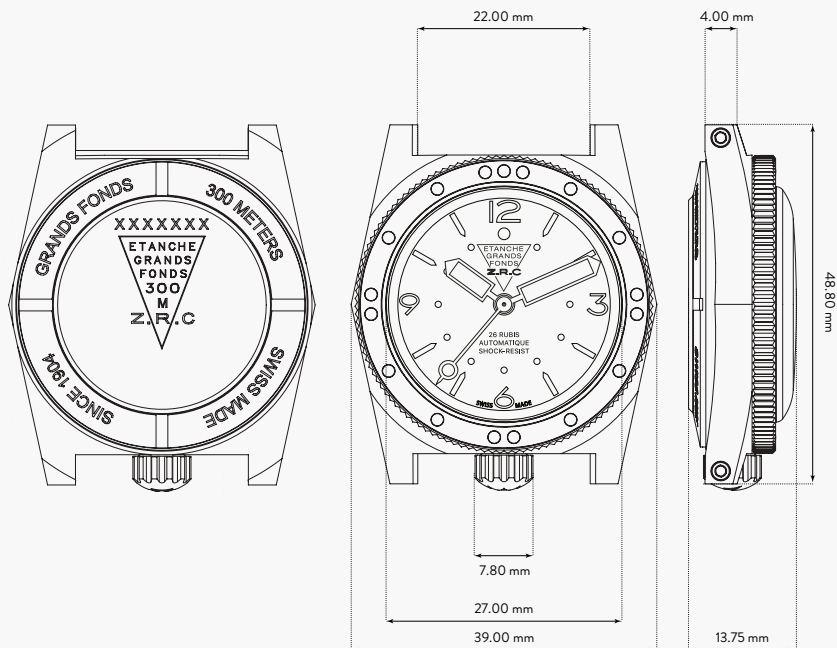

BOÎTIER / CASE

SPECIFICATION

Construction . Manufacture

Boîtier monobloc, fond et couronne vissés
Monobloc case screwed case back & crown

Diamètre . Diameter

39 mm

Matériaux . Materials

Acier inoxydable 316L amagnétique - Norme ISO764 : 4800 A/m
Nonmagnetic 316L Steel - ISO764 Standard: 4800 A/m

Lunette . Bezel

Lunette tournante unidirectionnelle crantée 60 divisions
avec insert en céramique
Unidirectional 60 divisions rotating bezel with ceramic insert

Couronne . Crown

Positionnée à 6H (Crown Protection System™)
Vissée double étanchéité à pas inversé
Located at 6H (Crown Protection System™)
Inverted screwed thread with dual sealing

Verre . Glass

Saphir bombé 2.4 mm anti-reflet
Sapphire 2.40 mm padded anti-reflection

Résistance à la pression
Pressure resistance

300 m

Profondeur testée . Tested depth

1000 m (151 bars)

MOUVEMENT / MOVEMENT

SPECIFICATION

Calibre . Calibre

SELLITA SW200-1 "Élaboré"
SELLITA "Elaborated" SW200-1

Réglage . Setting

+7sec/jour . +7sec/day

Amplitude . Amplitude

(± 7sec/jour) = de 0 à +14 sec/jour max
(± 7sec/day) = from 0 to 14 sec/day max

Remontage . Winding

Automatique . Automatic

Réserve de marche
Power reserve

38 h



GF38 - HERITAGE

LES DIFFÉRENTS MONTAGES THE DIFFERENT ASSEMBLING

TOUS LES MONTAGES
SONT COMPATIBLES

ALL ASSEMBLING
ARE COMPATIBLE

MONTAGE BRACELET ACIER METAL BAND ASSEMBLING (22x18 mm)

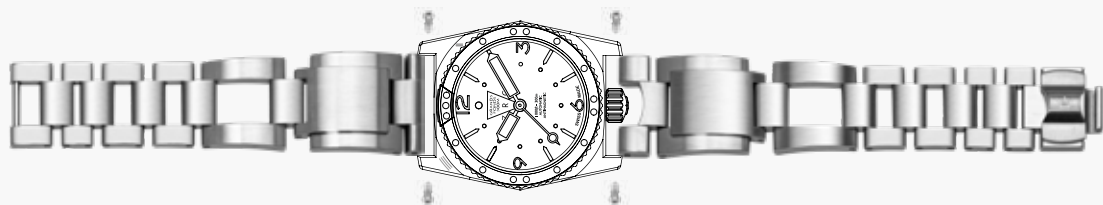

28.

MONTAGE NATO TYPE 1 TYPE 1 NATO ASSEMBLING (22x22 mm)

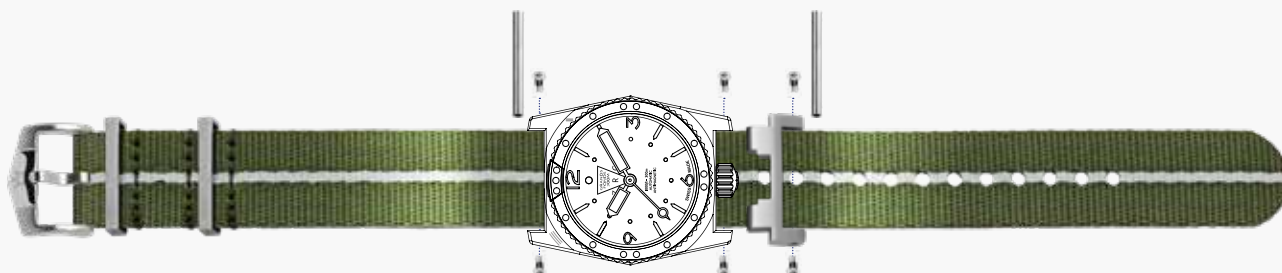

MONTAGE NATO TYPE 2 TYPE 2 NATO ASSEMBLING (22x22 mm)





TYPE 1



TYPE 2



GRANDS FONDS 38 - HERITAGE

MISE À TAILLE DU BRACELET
METAL BAND SIZING

NEW

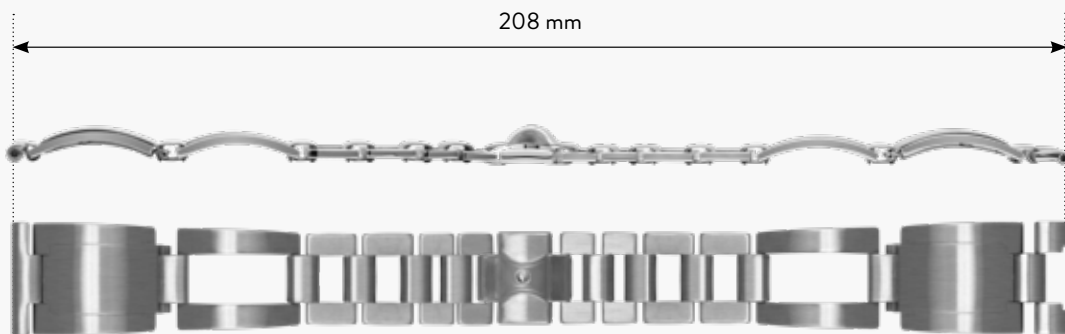

Amplitude de réglage maximum de 100 à 208 mm
Sizing capacity from 100 to 208 mm

30.

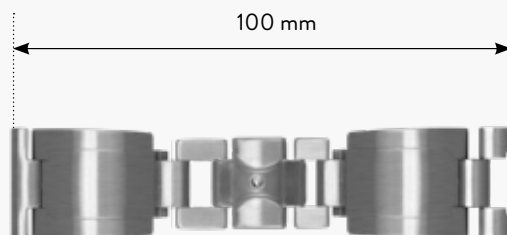

Regarder le tutoriel.
Watch the tutorial.



Mise à taille minimum avec maille ajourée
Minimum size with link

 Demi maillon feroir
1/2 clasp link

 Maillon feroir
Clasp link



1  Maillon
de connexion fermé
Connection
link closed

2 

3  Coquille
Shell
Maillon de
connexion ouvert
Connection
link opened
Clavette
Key





GF38 - HERITAGE



32.



GF38163
HERITAGE

3190,00



GF38263
HERITAGE

3190,00

GRANDS FONDS 300



GF38293
HERITAGE

3190,00

SELLITA SW200-1 "Elaboré". Réglage +7 sec (\pm 7 sec/jour) = de 0 à 14 sec/jour
SELLITA "Elaborated" SW200-1. Setting +7 sec (\pm 7 sec/day) = from 0 to 14 sec/day

34.





GRANDS FONDS 3000
TITANIUM

.35



INDEX



Système exclusif **ECS™**
du nettoyage de la lunette
(brevet N° 1462492)

Exclusive bezel
cleaning system **ECS™**
(patent N° 1462492)



Système exclusif **CPS™**
de protection de la
couronne

Exclusif **CPS™**
crown protection system



Profondeur 3000 m avec
couronne vissée

300 ATM water
resistance with screwed
crown



Verre saphir 5 mm
5 mm sapphire glass



Aiguilles SLN-X1
SLN-X1 hands



Mouvement
automatique
Automatic
movement



Anti-magnétique
Amagnetic



Fabriqu  en Suisse
Swiss made



Nickel free



Chrome free



Acier inoxydable
316L amagnétique
Nonmagnetic
316L Steel



Titane grade 2
Grade 2 Titanium



C ramique
Ceramic



Synth tique
(bracelet Nato)
Synthetic
(Nato strap)



Caoutchouc
(EPDM/NDR)
Rubber
(EPDM/NDR)



Registration, Evaluation,
Authorisation and
Restriction of Chemical



Restriction of the use
of certain **Hazardous**
Substances
in electrical and
electronic equipment



ISO 764 :
4800 A/m

36.



GRANDS FONDS 3000 TITANIUM

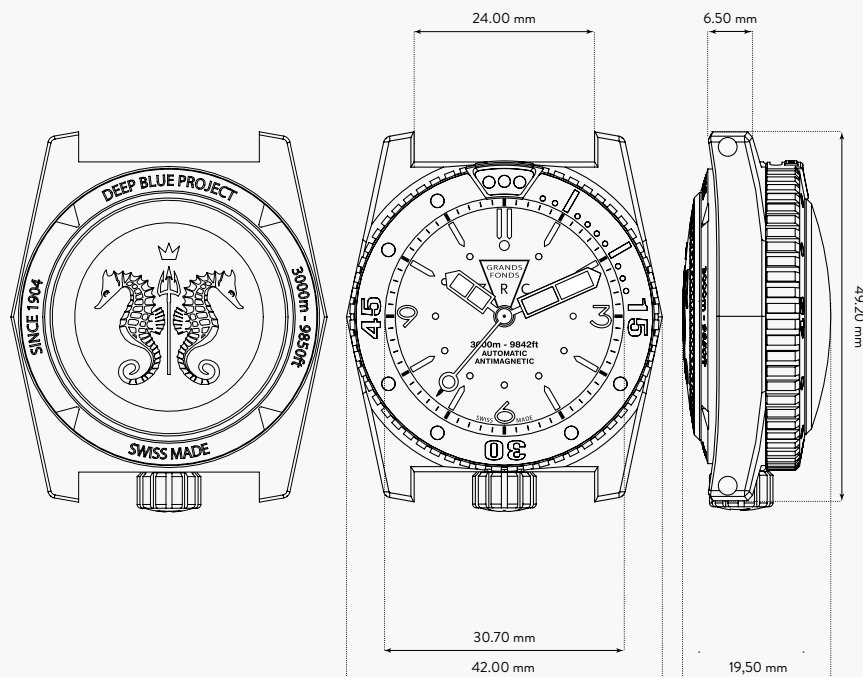

BOÎTIER / CASE

SPECIFICATION

Construction . Manufacture

Boîtier monobloc, fond et couronne vissés
Monobloc case screwed case back & crown

Diamètre . Diameter

42 mm

Matériaux . Materials

Titane grade II, Fond acier 316L blindé* (*Norme ISO764 : 4800 A/m)
Titanium grade II, 316L shielded* caseback (*ISO764 : 4800 A/m)

Lunette . Bezel

Système ECS™ (Brevet en cours). Lunette tournante unidirectionnelle
crantée 60 divisions en titane avec insert en céramique
ECS™ system (Patent pending N°1462496). Unidirectional
60 divisions rotating titan bezel with ceramic insert

Couronne . Crown

Positionnée à 6H (Crown Protection System™)
Vissée double étanchéité à pas inversé
Located at 6H (Crown Protection System™)
Inverted screwed thread with dual sealing

Verre . Glass

Saphir bombé 5 mm anti-reflet
Sapphire 5 mm padded, antireflective

Résistance à la pression
Pressure resistance

3000 m (301 bars)

Profondeur testée . Tested depth

5000 m (501 bars)

MOUVEMENT / MOVEMENT

SPECIFICATION

Calibre . Calibre

SELLITA SW200-1 "Élaboré" . SELLITA "Elaborated" SW200-1

Réglage . Setting

+7sec/jour . +7sec/day

Amplitude . Amplitude

(± 7sec/jour) = de 0 à +14 sec/jour max
(± 7sec/day) = from 0 to 14 sec/day max

Remontage . Winding

Automatique . Automatic

Réserve de marche
Power reserve

38 h



GF3000

LES DIFFÉRENTS MONTAGES
THE DIFFERENT ASSEMBLING

TOUS LES MONTAGES
SONT COMPATIBLES

ALL ASSEMBLING
ARE COMPATIBLE

MONTAGE NATO STRAP
NATO STRAP ASSEMBLING

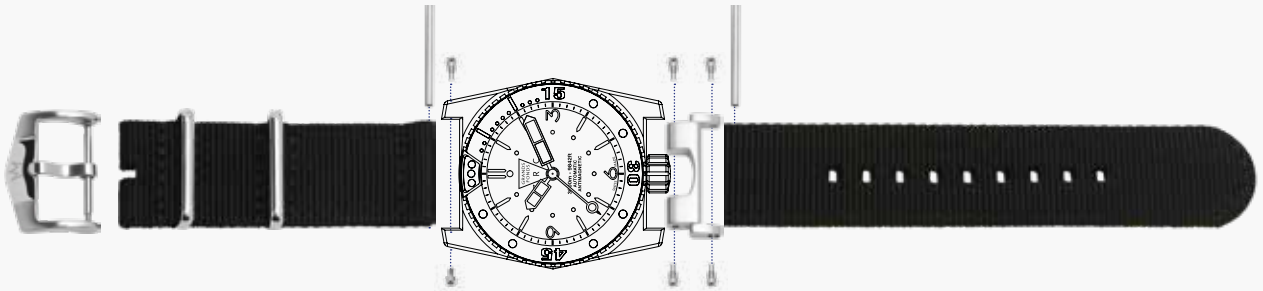

38.

MONTAGE BRACELET CAOUTCHOUC
RUBBER LEATHER STRAP ASSEMBLING

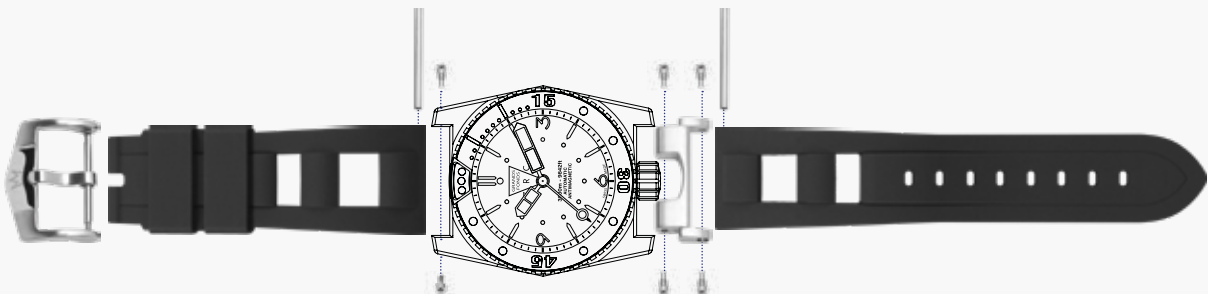



MONTAGE DE LA GF3000

ASSEMBLING OF THE GF3000



ZR70018
Allen : $\varnothing 1.27\text{mm}$



GF3000 TITANIUM



40.



Nato + outils à l'intérieur
Nato + tool inside
21 x 16,5 x 9 cm



GF50678
TITANIUM
4490.00



GF50699
TITANIUM
3990.00



GF50698
TITANIUM
3990.00

GRANDS FONDS 3000



GF50608
TITANIUM
3990.00



GF50618
TITANIUM
3990.00

Mouvement SELLITA SW200-1 "Elaboré"
Réglage +7 sec (± 7 sec/jour) = de 0 à 14 sec/jour
SELLITA "Elaborated" SW200-1
Setting +7 sec (± 7 sec/day) = from 0 to 14 sec/day



MAROQUINERIE HORLOGÈRE

WATCH LEATHER GOODS



1

NEW



2

42.

- 1 -

EM202406

Coffret 20 montres Alcantara
20 watches Alcantara box
28 x 32 x 8 cm

390.00 PP

- 2 -

EM062406

Coffret 6 montres Alcantara
6 watches Alcantara box
18 x 17,5 x 8,5cm

165.00 PP



3



4



5



6

- 3 -
EM082406

Coffret 8 montres Alcantara
8 watches Alcantara box
17,5 x 24,5 x 8,5cm

185.00 PP

- 4 -
EM042406

Coffret 4 montres Alcantara
4 watches Alcantara box
12,5 x 17,5 x 8,5cm

145.00 PP

- 5 -
RM032406

Rouleau 3 montres Alcantara
3 watches Alcantara roll
16,5 x 8,5 x 8,5cm

120.00 PP

- 6 -
EV012406

Ecrin 1 montre Alcantara
1 watch Alcantara box
10,5 x 9 x 7cm

105.00 PP



COFFRET BRACELET STRAPS BOX

CB012406K



**+ COFFRET EN ALCANTARA OFFERT !
+ ALCANTARA STRAP BOX FOR FREE!**

2325.00 HT
Excl. VAT













44.

*Regarder le tutoriel.
Watch the tutorial.*



*Offre uniquement valable sur cet assortiment de 39 références.
Offre limitée jusqu'à épuisement des stocks, non cummulaire avec d'autres promotions.
*This offer is on only for this set of 39 references. Limited offer until the out of stock,
may not be combined with any other offers or promotions.

CUIR / LEATHER		
REF/SKU	BRACELET / STRAP	PP
SGF4014M		100.00
SGF4017M		170.00
SGF4018M		150.00
SGF4032M		150.00
SGF4033M		150.00
SGF4034M		150.00

NATO		
REF/SKU	BRACELET / STRAP	PP
SGF4019M		90.00
SGF4019SM		90.00
SGF4020M		110.00
SGF4022M		110.00
SGF4023M		90.00
SGF4024M		90.00
SGF4025M		90.00
SGF4027M		110.00
SGF4028M		90.00
SGF4035SM		90.00
SGF4036SM		110.00
SGF4038SM		90.00
SGF4039SM		110.00

CAOUTCHOUC / RUBBER		
REF/SKU	BRACELET / STRAP	PP
SGF5000M		130.00
SGF5001L		130.00
SGF5001M		130.00
SGF5002M		130.00
SGF5003M		130.00
SGF5004L		130.00
SGF5004M		130.00
SGF5005M		130.00
SGF5006L		130.00
SGF5006M		130.00
SGF5008M		130.00
SGF5009M		130.00
SGF5011M		130.00
SGF5012M		130.00
SGF5018M		130.00
SGF5019M		130.00
SGF5028L		130.00
SGF5028M		130.00
SGF5033L		130.00
SGF5033M		130.00



BRACELETS : MÉTAL & CUIR “ANSES DROITES”

METAL BANDS & LEATHER STRAPS “STRAIGHT ENDS”

COMPATIBLE GF300 + GF3000



SGF4116

Bracelet métal acier inox 316L avec extensions plongée - 24mm
316L Solid stainless steel metal band with diving extensions - 24mm

750.00

**Attention : vis vendues séparément (triangle/Allen) voir page 100. Warning : Screws sold separately (Triangle/Allen) See page 100.*



SGF3816

Bracelet métal acier inox 316L avec extensions plongée - 22mm
316L Solid stainless steel metal band with diving extensions - 22mm

375.00

**Attention : vis vendues séparément (triangle/Allen) voir page 104. Warning : Screws sold separately (Triangle/Allen) See page 104.*



SGF4014 (M) M : 115 x 80 mm

Bracelet Bulgaro noir, piqures blanches / Black calf, white stitching

100.00



SGF4017 (S, M, L) S : 110 x 70 mm / M : 115 x 80 mm / L : 125 x 90 mm

Bracelet veau gold vintage coutures écru / Calf vintage leather strap rawsilk stitching

170.00

Regarder le tutorial.
Watch the tutorial.





BRACELETS : CUIR “ANSES DROITES”

LEATHER STRAPS “STRAIGHT ENDS”

COMPATIBLE GF300 + GF3000



SGF4018 (S, M, L) S : 110 x 70 mm / M : 115 x 80 mm / L : 125 x 90 mm

Bracelet veau gold vintage coutures écrues / Calf vintage leather strap rawsilk stitching

150.00



SGF4032 (S, M, L) S : 110 x 70 mm / M : 115 x 80 mm / L : 125 x 90 mm

Bracelet vachette marron vintage, coutures écrues / Vintage cowhide brown strap, rawsilk stitching

150.00



SGF4033 (S, M, L) S : 110 x 70 mm / M : 115 x 80 mm / L : 125 x 90 mm

Bracelet vachette bleu marine vintage, coutures écrues / Vintage cowhide navy blue strap, rawsilk stitching

150.00



SGF4034 (S, M, L) S : 110 x 70 mm / M : 115 x 80 mm / L : 125 x 90 mm

Bracelet vachette vert foncé vintage, coutures écrues / Vintage cowhide dark green strap, rawsilk stitching

150.00



SGF4037MMA (M) M : 115 x 80 mm

Bracelet vachette orange vintage, coutures écrues / Vintage cowhide orange strap, rawsilk stitching

150.00





BRACELETS NATO

NATO STRAPS

COMPATIBLE GF300 + GF3000



SGF4019 (S, SM, M, L) S : 105 x 70 mm / SM : 120 x 70 mm / M : 135 x 70 mm / L : 165 x 90 mm

Bracelet Nato nylon noir, finition acier / Black nylon Nato strap, steel finish

90.00



SGF4020 (S, SM, M, L) S : 105 x 70 mm / SM : 120 x 70 mm / M : 135 x 70 mm / L : 165 x 90 mm

Bracelet Nato nylon noir, finition DLC / Black nylon Nato strap, DLC finish

110.00

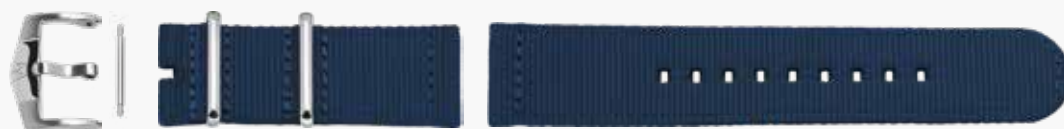

SGF4026S (S, SM, M) S : 105 x 70 mm / SM : 120 x 70 mm / M : 135 x 70 mm

Bracelet Nato nylon bleu marine, finition acier / Navy blue nylon Nato strap, steel finish

90.00

48.

Regarder le tutoriel.
Watch the tutorial.





SGF4035 (S, SM, M, L) S : 105 x 70 mm / SM : 120 x 70 mm / M : 135 x 70 mm / L : 165 x 90 mm

Bracelet Nato nylon noir, finition inox / Black nylon Nato strap, inox finish

90.00



SGF4036 (S, SM, M, L) S : 105 x 70 mm / SM : 120 x 70 mm / M : 135 x 70 mm / L : 165 x 90 mm

Bracelet Nato nylon noir, finition inox DLC / Black nylon Nato strap, DLC inox finish

110.00



SGF4038 (S, SM, M, L) S : 105 x 70 mm / SM : 120 x 70 mm / M : 135 x 70 mm / L : 165 x 90 mm

Kit bracelet Nato rayé, finition acier / Striped nylon Nato strap kit, steel finish

90.00



SGF40146 (S, M, L) S : 105 x 70 mm / M : 135 x 70 mm / L : 165 x 90 mm

Bracelet Nato nylon noir "North Adventure", finition acier / Black nylon Nato strap "North Adventure", steel finish

100.00





BRACELETS NATO GF38 HERITAGE

GF38 HERITAGE NATO STRAPS

COMPATIBLE BOÎTIER 22mm

TYPE 2

NEW



SGF383201

Bracelet Nato nylon noir + Velcro, finition acier / Black nylon Nato strap + Velcro, steel finish

90.00

NEW



SGF383205

Bracelet Nato nylon noir et rouge + Velcro, finition acier / Black and red nylon Nato strap + Velcro, steel finish

90.00

NEW



SGF383206

Bracelet Nato nylon bleu marine et rouge + Velcro, finition acier

90.00

Navy blue and red nylon Nato strap + Velcro, steel finish



TYPE 1



SGF383101

Bracelet Nato nylon noir et beige, finition acier / Black and beige nylon Nato strap, steel finish

90.00



SGF383128

Bracelet Nato nylon kaki et blanc, finition acier / Navy khaki and white nylon Nato strap, steel finish

90.00





BRACELETS CAOUTCHOUC EPDM

EPDM RUBBER STRAPS

COMPATIBLE GF300 + GF3000

ZRC a choisi le matériau EPDM pour ses bracelets. Cette matière apparue en 1963 est un élastomère spécial préconisé pour résister aux fluides pouvant être corrosif. L'EPDM offre une bonne élasticité, une souplesse et une haute imperméabilité. Son utilisation est très utile dans le domaine de l'étanchéité. L'EPDM est le caoutchouc par excellence lorsqu'il s'agit de résister aux intempéries et offre une forte résistance aux variations de températures de -40°C à +100°C. Il peut ainsi être soumis à la pluie et au soleil tout en conservant ses propriétés mécaniques.

Dans ces conditions nos bracelets offrent une excellente durée de vie. Résistant aux agressions alcalines et acides l'EPDM offre également une excellente compatibilité avec l'eau et la vapeur d'eau. C'est un « tool band » qui, une fois monté sur votre ZRC, saura vous accompagner dans toutes vos aventures.

ZRC chose the EPDM material for its straps. This material appeared in 1963 is a special elastomer recommended to resist to corrosive fluids. The EPDM offers good elasticity, flexibility and high waterproofness. Its use is very useful in the sealing field. EPDM is "the rubber" par excellence when it comes to weather resistance and offers a high resistance to temperature variations from -40°C to +100°C. It can be subjected to rain and sun while maintaining its mechanical properties. In these conditions our bracelets offer an excellent lifespan.

Resistant to alkaline and acid aggressions, EPDM also offers excellent compatibility with water and steam. It is a « tool band » that, once mounted on your ZRC, will accompany you in all your adventures.

Caractéristiques techniques / Technical characteristics :

Densité / Density : 1.3 g/cm³

Dureté : 70° Sh.A

Températures / Temperatures : -40 à +100 °C

Résistance à la rupture / Fracture resistance : 7 n/mm²

Allongement / Extension : 250%

	MOYEN AVERAGE	BON GOOD	EXCELLENT
Intempéries . Elements			●
Ozone			●
Alcalis . Alkali			●
Acides . Acids		●	
Huiles . Oils	●		
Hydrocarbures	●		
Abrasion	●		

Regarder le tutoriel.
Watch the tutorial.



CAOUTCHOUC EPDM EPDM RUBBER

REF/SKU	BRACELET / STRAP	M	L	PP
		115x70 mm	135x80 mm	
SGF5000		•		130.00
SGF5004		•	•	130.00
SGF5006		•	•	130.00
SGF5011		•		130.00
SGF5012		•		130.00
SGF5018		•		130.00

.53





BRACELETS CAOUTCHOUC FKM

FKM RUBBER STRAPS

COMPATIBLE GF300 + GF3000

ZRC a choisi le FKM pour ses bracelets, cet élastomère a été spécialement développé pour l'industrie aéronautique capable de résister aux fluides chimiques, huiles et carburants ainsi qu'aux températures extrêmes et à l'abrasion.

Le FKM résiste très bien aux UV, ozone et offre une bonne élasticité. Son utilisation est très utile dans le domaine de l'étanchéité. Le FKM est le caoutchouc par excellence lorsqu'il s'agit de résister aux intempéries et offre une forte résistance aux variations de températures extrêmes tout en conservant ses propriétés mécaniques.

Dans ces conditions nos bracelets offrent une excellente durée de vie. Résistant aux agressions alcalines et acides. Le FKM offre également une excellente compatibilité avec l'eau et la vapeur d'eau. C'est un « tool band » qui, une fois monté sur votre ZRC, saura vous accompagner dans toutes vos aventures.

ZRC as chosen the FKM for its bracelets, this elastomer has been specially developed for the aerospace industry capable of resisting chemical fluids, oils and fuels as well as extreme temperatures and abrasion.

The FKM resists very well to UV, ozone and offers good elasticity. Its use is very useful in the field of waterproofing. The FKM is the rubber par excellence when it comes to weather resistance and offers a strong resistance to extreme temperature variations while maintaining its mechanical properties.

In these conditions our bracelets offer an excellent lifespan. Resistant to alkaline and acid aggressions the FKM also offers excellent compatibility with water and water vapor. It is a « tool band » that, once mounted on your ZRC, will accompany you in all your adventures.

Caractéristiques techniques / Technical characteristics :

Densité / Density : 1.3 g/cm³

Dureté : 70° Sh.A

Températures / Temperatures : -40 à +100 °C

Résistance à la rupture / Fracture resistance : 7 n/mm²

Allongement / Extension : 250%

	MOYEN AVERAGE	BON GOOD	EXCELLENT
Huiles . Oils			●
Température			●
Ozone			●
Déformation à la compression . Compression deformation			●
Chimique . Chemical		●	
Traction . Traction		●	
Déchirement . Tearing	●		

54.

Regarder le tutoriel.
Watch the tutorial.



CAOUTCHOUC FKM
FKM RUBBER

REF/SKU	BRACELET / STRAP	M 115x70 mm	L 135x80 mm	PP
SGF5001		•	•	130.00
SGF5005		•		130.00
SGF5009		•	•	130.00
SGF5019		•	•	130.00
SGF5033		•	•	130.00

.55





KIT : CUIR "ANSES DÉCOUPÉES"

LEATHER STRAPS KIT "CUT EDGES"

COMPATIBLE GF300 V1



BGF4005 (S, M) S : 110 x 70 mm / M : 115 x 80 mm

Bracelet cuir bulgare coutures rouges + boucle déployante réglable / Bulgaro leather strap red stitching with adjustable folding buckle

250.00



BGF4010 (M) M : 115 x 80 mm

Bracelet cuir bulgare + boucle déployante réglable / Bulgaro leather strap with adjustable folding buckle

250.00



BGF4011 (M) M : 115 x 80 mm

Bracelet cuir bulgare + boucle déployante réglable / Bulgaro leather strap with adjustable folding buckle

250.00



BGF4015 (S, M) S : 110 x 70 mm / M : 115 x 80 mm

Bracelet cuir bulgare coutures rouges + boucle déployante réglable / Bulgaro leather strap red stitching with adjustable folding buckle

250.00



BGF4030 (M) M : 115 x 80 mm

Bracelet cuir bulgare coutures oranges + boucle déployante réglable / Bulgaro leather strap orange stitching with adjustable folding buckle

250.00



BGF4031 (M) M : 115 x 80 mm

Bracelet veau façon alligator gold + boucle déployante réglable / Calf alligator grain rawsilk stitching with adjustable folding buckle

280.00



S : 110x70 mm / M : 115x80 mm / L : 125x90 mm

56.



BRACELETS : CUIR “ANSES DÉCOUPÉES”

LEATHER STRAPS “CUT EDGES”

COMPATIBLE GF300 V1



SGF4005 (S, M) S : 110 x 70 mm / M : 115 x 80 mm

Bracelet cuir bulgare coutures rouges / Bulgaro leather strap red stitching

110.00



SGF4010 (M) M : 115 x 80 mm

Bracelet cuir bulgare / Bulgaro leather strap

110.00



SGF4011 (M) M : 115 x 80 mm

Bracelet cuir bulgare / Bulgaro leather strap

110.00



SGF4015 (S, M) S : 110 x 70 mm / M : 115 x 80 mm

Bracelet cuir bulgare coutures rouges / Bulgaro leather strap red stitching

110.00



SGF4030 (M) M : 115 x 80 mm

Bracelet cuir bulgare coutures oranges / Bulgaro leather strap orange stitching

110.00



SGF4031 (M) M : 115 x 80 mm

Bracelet veau façon alligator gold / Calf alligator grain rawsilk stitching

170.00



S : 110x70 mm / M : 115x80 mm / L : 125x90 mm

.57



ANSES ADAPTABLES NATO, CUIR, CAOUTCHOUC

NATO, LEATHER, RUBBER, ADAPTABLE ENDS

GF300 / GF3000 / GF38

Boîtiers 4000, 4000E, 4000E2 / 4000, 4000E, 4000E2 cases



SGF400165

Kit (6h) acier satiné
Nato/Cuir/Caoutchouc

6h satined steel kit
Nato/Leather/Rubber

120.00



SGF400251

Kit (6h) acier sablé
Nato/Cuir/Caoutchouc

6h sandblasted steel kit
Nato/Leather/Rubber

120.00



SGF400185

Kit (6h) acier DLC satiné
Nato/Cuir/Caoutchouc

6h DLC satined steel kit
Nato/Leather/Rubber

170.00



SGF400211

Kit (6h) acier DLC sablé
Nato/Cuir/Caoutchouc

6h DLC sandblasted steel kit
Nato/Leather/Rubber

170.00

GF300

Boîtiers 4100 / 4100 cases



SGF411501

Kit (6h) acier satiné
Nato/Cuir/Caoutchouc

6h satined steel kit
Nato/Leather/Rubber

170.00



SGF411502

Kit (6h) acier sablé
Nato/Cuir/Caoutchouc

6h sandblasted steel kit
Nato/Leather/Rubber

170.00



SGF411504

Kit (6h) acier DLC satiné
Nato/Cuir/Caoutchouc

6h DLC satined steel kit
Nato/Leather/Rubber

195.00



SGF411503

Kit (6h) acier DLC sablé
Nato/Cuir/Caoutchouc

6h DLC sandblasted steel kit
Nato/Leather/Rubber

195.00

58.

GF3000



SGF500224

Anse (6h) satinée - Titane
6 screws satined end - Titanium

250.00



SGF500225

Anse (6h) sablée - Titane
6h sandblasted end - Titanium

250.00



SGF500226

Anse (6h) DLC sablé - Titane
6h DLC sandblasted end - Titanium

300.00

GF38

NEW



SGF381501

Kit (6h) acier satiné
Nato/Cuir/Caoutchouc
6h satined steel kit
Nato/Leather/Rubber

170.00



BOUCLES SIMPLE ARDILLON & PAPILLON

SINGLE TONGUE BUCKLES & BUTTERFLY

ACIER - STEEL

Tailles Sizes	1. Satiné poli Polish satin	2. Sablé Sandblasted	3. Satiné DLC DLC satiné	4. Sablé DLC DLC sandblasted	5. Satiné Poli Polish satin	
20 mm	ZBSS020	ZBSS320	ZBSS120	ZBSS220	ZGF400046	
22 mm	ZBSS022	-	-	-	-	
24 mm	ZBSS024	ZBSS324	ZBSS124	ZBSS224	-	
	35.00	35.00	45.00	45.00	130.00	

TITANE - TITANIUM

Tailles Sizes	Satiné Satin	Sablé Sandblasted	Sablé DLC DLC Sandblasted
20 mm	ZBTI020	ZBTI320	ZBTI220
	70.00	70.00	90.00

BRONZE

Tailles Sizes	Satiné Satin
20 mm	ZBBR020
	250.00

.59

GF38



SGF380262

Kit tubes (12h + 6h) - Acier - 22 mm
12h + 6h tube kit - Steel - 22 mm

25.00



GF300



SGF500262

Kit tubes (12h + 6h) - Acier - 24 mm
12h + 6h tube kit - Steel - 24 mm

25.00

GF3000



SGF500263

Kit tubes (12h + 6h) - Titane - 24 mm
12h + 6h tube kit - Titanium - 24 mm

65.00

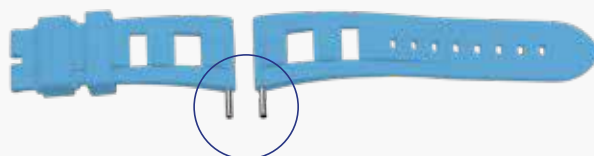



KIT RÉPARATION

REPAIR KIT

KSAV40

Grands Fonds 300
(Pour/for 4000, 4000E, 4000E2)

460.00
HT/Excl. VAT



CONTENU DE LA BOITE / BOX CONTENT

REF	QTY	PU HT	REF	QTY	PV HT	
SGF400165	2	60.00	SGF400197	1	40.00	
			SGF400195	1	22.50	
			SGF400196	1	22.50	
SGF400047	3	30.00	SGF400043	1	12.50	
SGF400050	2	12.50	SGF500267	1	12.50	
SGF400045	2	12.50				
SGF400051	1	40.00	SGF411301	SGF400036	5	2.50
SGF400052	1	22.50		5	250	
SGF400056	1	22.50				

CONTENU DE LA BOITE / BOX CONTENT

REF	QTY	PU HT	REF	QTY	PV HT
SGF411501	2	85.00	SGF412301	5	5.50
			SGF412401	5	5.50
SGF411601	2	40.00	SGF411301	5	2.50
SGF411602	1	40.00	SGF411401	5	2.50
SGF411603	1	45.00	/		
SGF411604	1	45.00			

460.00
HT/Excl. VAT

KSAV41

Grands Fonds 300
(Pour/for 4100)



60.

CONTENU DE LA BOITE / BOX CONTENT

REF	QTY	PU HT	REF	QTY	PV HT
SGF500221	1	27.50	SGF500266	5	5.50
			SGF500265	5	5.50
SGF500222	1	27.50	SGF500247	5	3.00
			SGF500245	5	3.00
SGF500223	1	40.00	/		

180.00
HT/Excl. VAT

KSAV50

Grands Fonds 3000
(Pour/for 5000)



CONTENU DE LA BOITE / BOX CONTENT

REF	QTY	PU HT	REF	QTY	PV HT
SGF381501	3	85.50	SGF381301	3	2.50
SGF411601	3	40.00	SGF382801	3	2.50
SGF380262	2	12.50	SGF381401	2	2.50

420.00
HT/Excl. VAT

KSAV38

Grands Fonds 38
(Pour/for 38)





KSAV99
Kit réparation bracelets
Straps and bands repair kit

928.00
 HT/Excl. VAT

CONTENU DE LA BOITE / BOX CONTENT

	REF	QTY	PU HT	REF	QTY	PU HT	REF	QTY	PU HT
1	SGF400102	5	4.50	SGF400230	1	3.00	SGF400226	2	42.50
	SGF400231	5	4.50				SGF400235	2	42.50
	SGF400208	5	3.00						
2	ZBSS020	1	17.50	ZBSS024	1	17.50	SGF400234	1	47.50
	ZBSS320	1	17.50	ZBSS324	1	17.50			
	ZBSS120	1	22.50	ZBSS124	1	22.50			
	ZBSS220	1	22.50	ZBSS224	1	22.50			
3	ZGF400046	1	65.00	SGF400221	1	42.50	SGF400029	5	5.50
	SGF400302	5	5.00						
	SGF400303	5	5.00						
4	SGF40133	1	42.50	SGF400222	1	57.50	SGF40131	1	2.50
							SGF400026	1	32.50
	SGF40118	2	42.50	SGF400228	1	57.50	SGF400050	1	12.50
							SGF400043	1	12.50



RÉÉDITION MN64

MN64 REISSUE



62.



GF41163

NOMENCLATURE

	REF/SKU	DESIGNATION (FR)	DESIGNATION (UK)	PP
1	SGF412501	Verre saphir	Sapphire crystal	290.00
2	SGF411201	Joint de verre	Gasket for glass	6.00
3	SGF412701	Capsule SLN	SLN capsule	7.00
4	SGF411701	Lunette acier	Steel bezel	680.00
5	SGF411901	Ressort de lunette	Bezel spring	11.00
6	SGF411601	Kit x4 vis Allen	Set of x4 Allen screws	80.00
7	SGF410601	Boîtier	Watch case	590.00
8	SGF410401	Cliquet à pivot	Spring loaded ball	45.00
9	SGF410101	Aiguilles Magnum	Magnum hands	70.00
10	SGF410701	Cadran	Dial	150.00
11	SGF412601	Vis de fixation mouvement	Movement fixing screw	6.00
12	SGF410801	Cercle d'emboîtement	Coupler circle	60.00
13	SGF412001	Ressort de cercle d'emboîtement	Circle fitting spring	30.00
14	SGF411401	Joint de fond	O'ring caseback	5.00
15	SGF411101	Fond central Boîtier	Caseback	55.00
16	SGF410301	Bague de fond	Caseback ring	50.00
17	SGF412201	Tube de couronne	Steel crown tube	30.00
18	SGF411301	Joint de couronne	Crown Oring	5.00
19	SGF410901	Couronne	Crown	70.00
20	SGF411802	Mouvement	Movement	890.00
22	SGF412101	Tige de remontoir	Winding stem	11.00
21	SGF4116	Bracelet métal	Metal band	750.00

.63



RÉÉDITION MN64

MN64 REISSUE



GF41168

NOMENCLATURE

	REF/SKU	DESIGNATION (FR)	DESIGNATION (UK)	PP
1	SGF412501	Verre saphir	Sapphire crystal	290.00
2	SGF411201	Joint de verre	Gasket for glass	6.00
3	SGF412701	Capsule SLN	SLN capsule	7.00
4	SGF411701	Lunette	Bezel	680.00
5	SGF411901	Ressort de lunette	Bezel spring	11.00
6	SGF412301	Tube 12h	12H Tube	11.00
7	SGF410601	Boîte	Watch case	590.00
8	SGF410401	Cliquet à pivot	Spring loaded ball	45.00
9	SGF410101	Aiguilles magnum	Magnum Hands	70.00
10	SGF410701	Cadran	Dial	150.00
11	SGF412601	Vis de fixation mouvement	Movement fixing screw	6.00
12	SGF410801	Cercle d'emboîtement	Coupler circle	60.00
13	SGF412001	Ressort de cercle d'emboîtement	Circle fitting spring	30.00
14	SGF411401	Joint de fond	Caseback O'ring	5.00
15	SGF411101	Fond de boîtier central	Central caseback part	55.00
16	SGF410301	Bague de fond	Caseback ring	50.00
17	SGF411601	kit x4 vis Allen	Set of x4 Allen screws	80.00
18	SGF412201	Tube de couronne	Steel crown tube	30.00
19	SGF411301	Joint de couronne	Crown O'ring	5.00
20	SGF410901	Couronne	Crown	70.00
21	SGF410201	Anse NATO	NATO end	60.00
22	SGF412401	Tube 6H	6H Tube	11.00
23	SGF411802	Mouvement	Movement	890.00
24	SGF412101	Tige de remontoir	Winding stem	11.00
25	SGF410502	Boîte complete	Watch case set	1 830.00
26	SGF411501	Kit montage Nato/Nato/Rubber/Cuir	Set of Nato/Rubber/Leather assembly	170.00

.65



RÉÉDITION MN64

MN64 REISSUE



GF41178

NOMENCLATURE

	REF/SKU	DESIGNATION (FR)	DESIGNATION (UK)	PP
1	SGF412501	Verre saphir	Sapphire crystal	290.00
2	SGF411201	Joint de verre	Gasket for glass	6.00
3	SGF412702	Capsule SLN	SLN capsule	7.00
4	SGF411705	Lunette	Bezel	720.00
5	SGF411901	Ressort de lunette	Bezel spring	11.00
6	SGF412301	Tube 12h	12H Tube	11.00
7	SGF410604	Boîte	Watch case	620.00
8	SGF410401	Cliquet à pivot	Spring loaded ball	45.00
9	SGF410102	Aiguilles magnum	Magnum Hands	75.00
10	SGF410707	Cadran	Dial	150.00
11	SGF412601	Vis de fixation mouvement	Movement fixing screw	6.00
12	SGF410801	Cercle d'emboîtement	Coupler circle	60.00
13	SGF412001	Ressort de cercle d'emboîtement	Circle fitting spring	30.00
14	SGF411401	Joint de fond	Caseback O'ring	5.00
15	SGF411104	Fond de boîtier central	Central caseback part	70.00
16	SGF410302	Bague de fond	Caseback ring	60.00
17	SGF411603	kit x4 vis Allen	Set of x4 Allen screws	90.00
18	SGF412201	Tube de couronne	Steel crown tube	30.00
19	SGF411301	Joint de couronne	Crown O'ring	5.00
20	SGF410904	Couronne	Crown	80.00
21	SGF410202	Anse NATO	NATO end	75.00
22	SGF412401	Tube 6H	6H Tube	11.00
23	SGF411802	Mouvement	Movement	890.00
24	SGF412101	Tige de remontoir	Winding stem	11.00
25	SGF410507	Boîte complete	Watch case set	2000.00
26	SGF411504	Kit montage Nato/Cuir	Set of Nato/Leather strap assembly	185.00

.67



RÉÉDITION MN64

MN64 REISSUE



68.

GF41199

NOMENCLATURE

	REF/SKU	DESIGNATION (FR)	DESIGNATION (UK)	PP
1	SGF412501	Verre saphir	Sapphire crystal	290.00
2	SGF411201	Joint de verre	Gasket for glass	6.00
3	SGF412701	Capsule SLN	SLN capsule	7.00
4	SGF411701	Lunette	Bezel	680.00
5	SGF411901	Ressort de lunette	Bezel spring	11.00
6	SGF412301	Tube 12h	12H Tube	11.00
7	SGF410601	Boîte	Watch case	590.00
8	SGF410401	Cliquet à pivot	Spring loaded ball	45.00
9	SGF410107	Aiguilles magnum	Magnum Hands	70.00
10	SGF410711	Cadran	Dial	330.00
11	SGF412601	Vis de fixation mouvement	Movement fixing screw	6.00
12	SGF410801	Cercle d'emboîtement	Coupler circle	60.00
13	SGF412001	Ressort de cercle d'emboîtement	Circle fitting spring	30.00
14	SGF411401	Joint de fond	Caseback O'ring	5.00
15	SGF411101	Fond de boîtier central	Central caseback part	55.00
16	SGF410301	Bague de fond	Caseback ring	50.00
17	SGF411601	kit x4 vis Allen	Set of x4 Allen screws	80.00
18	SGF412201	Tube de couronne	Steel crown tube	30.00
19	SGF411301	Joint de couronne	Crown O'ring	5.00
20	SGF410901	Couronne	Crown	70.00
21	SGF410201	Anse NATO	NATO end	60.00
22	SGF412401	Tube 6H	6H Tube	11.00
23	SGF411801	Mouvement	Movement	890.00
24	SGF411005	Disque de date	Date disk	35.00
25	SGF412101	Tige de remontoir	Winding stem	11.00
26	SGF410502	Boîte complete	Watch case set	1830.00
27	SGF411501	Kit montage Nato/Cuir	Set of Nato/Leather strap assembly	170.00



RÉÉDITION MN64

MN64 REISSUE



GF41103 - RUTHENIUM

NOMENCLATURE

	REF/SKU	DESIGNATION (FR)	DESIGNATION (UK)	PP
1	SGF412501	Verre saphir	Sapphire crystal	290.00
2	SGF411201	Joint de verre	Gasket for glass	6.00
3	SGF412701	Capsule SLN	SLN capsule	7.00
4	SGF411701	Lunette	Bezel	680.00
5	SGF411901	Ressort de lunette	Bezel spring	11.00
6	SGF412301	Tube 12h	12H Tube	11.00
7	SGF410602	Boîte	Watch case	590.00
8	SGF410401	Cliquet à pivot	Spring loaded ball	45.00
9	SGF410101	Aiguilles magnum	Magnum Hands	70.00
10	SGF410710	Cadran	Dial	330.00
11	SGF412601	Vis de fixation mouvement	Movement fixing screw	6.00
12	SGF410801	Cercle d'emboîtement	Coupler circle	60.00
13	SGF412001	Ressort de cercle d'emboîtement	Circle fitting spring	30.00
14	SGF411401	Joint de fond	Caseback O'ring	5.00
15	SGF410303	Bague de fond	Caseback ring	50.00
16	SGF411102	Fond de boîtier central	Central caseback part	55.00
17	SGF411602	kit x4 vis Allen	Set of x4 Allen screws	80.00
18	SGF412201	Tube de couronne	Steel crown tube	30.00
19	SGF411301	Joint de couronne	Crown O'ring	5.00
20	SGF410902	Couronne	Crown	70.00
21	SGF410203	Anse NATO	NATO end	60.00
22	SGF412401	Tube 6H	6H Tube	11.00
23	SGF411801	Mouvement	Movement	890.00
24	SGF411004	Disque de date	Date disk	35.00
25	SGF412101	Tige de remontoir	Winding stem	11.00
25	SGF410503	Bwoîte complete	Watch case set	1830.00
26	SGF411502	Kit montage Nato/Cuir	Set of Nato/Leather strap assembly	170.00

.71



RÉÉDITION MN64

MN64 REISSUE



72.



GF41203

NOMENCLATURE

	REF/SKU	DESIGNATION (FR)	DESIGNATION (UK)	PP
1	SGF412501	Verre saphir	Sapphire crystal	290.00
2	SGF411201	Joint de verre	Gasket for glass	6.00
3	SGF412701	Capsule SLN	SLN capsule	7.00
4	SGF411701	Lunette acier	Steel bezel	680.00
5	SGF411901	Ressort de lunette	Bezel spring	11.00
6	SGF411601	Kit x4 vis Allen	Set of x4 Allen screws	80.00
7	SGF410601	Boîtier	Watch case	590.00
8	SGF410401	Cliquet à pivot	Spring loaded ball	45.00
9	SGF410101	Aiguilles Magnum	Magnum hands	70.00
10	SGF410702	Cadran	Dial	150.00
11	SGF412601	Vis de fixation mouvement	Movement fixing screw	6.00
12	SGF410801	Cercle d'emboîtement	Coupler circle	60.00
13	SGF412001	Ressort de cercle d'emboîtement	Circle fitting spring	30.00
14	SGF411401	Joint de fond	O'ring caseback	5.00
15	SGF410301	Bague de fond	Caseback ring	50.00
16	SGF411101	Fond central Boîtier	Caseback	55.00
17	SGF412201	Tube de couronne	Steel crown tube	30.00
18	SGF411301	Joint de couronne	Crown Oring	5.00
19	SGF410901	Couronne	Crown	70.00
20	SGF411801	Mouvement	Movement	890.00
21	SGF411001	Disque de date	Date disk	35.00
22	SGF412101	Tige de remontoir	Winding stem	11.00
23	SGF4116	Kit bracelet métal	Set of metal band	750.00

.73



RÉÉDITION MN64

MN64 REISSUE



GF41198

NOMENCLATURE

	REF/SKU	DESIGNATION (FR)	DESIGNATION (UK)	PP
1	SGF412501	Verre saphir	Sapphire crystal	290.00
2	SGF411201	Joint de verre	Gasket for glass	6.00
3	SGF412703	Capsule SLN	SLN capsule	7.00
4	SGF411704	Lunette	Bezel	720.00
5	SGF411901	Ressort de lunette	Bezel spring	11.00
6	SGF412301	Tube 12h	12H Tube	11.00
7	SGF410603	Boîte	Watch case	620.00
8	SGF410401	Cliquet à pivot	Spring loaded ball	45.00
9	SGF410106	Aiguilles magnum	Magnum Hands	75.00
10	SGF410706	Cadran	Dial	330.00
11	SGF412601	Vis de fixation mouvement	Movement fixing screw	6.00
12	SGF410801	Cercle d'emboîtement	Coupler circle	60.00
13	SGF412001	Ressort de cercle d'emboîtement	Circle fitting spring	30.00
14	SGF411401	Joint de fond	Caseback O'ring	5.00
15	SGF411103	Fond de boîtier central	Central caseback part	70.00
16	SGF410304	Bague de fond	Caseback ring	60.00
17	SGF411604	kit x4 vis Allen	Set of x4 Allen screws	90.00
18	SGF412201	Tube de couronne	Steel crown tube	30.00
19	SGF411301	Joint de couronne	Crown O'ring	5.00
20	SGF410903	Couronne	Crown	80.00
21	SGF410204	Anse NATO	NATO end	75.00
22	SGF412401	Tube 6H	6H Tube	11.00
23	SGF411801	Mouvement	Movement	890.00
24	SGF411003	Disque de date	Date disk	35.00
25	SGF412101	Tige de remontoir	Winding stem	11.00
26	SGF410508	Boîte complete	Watch case set	2000.00
27	SGF411503	Kit montage Nato/Cuir	Set of Nato/Leather strap assembly	185.00

.75



RÉÉDITION MN64

MN64 REISSUE



GF41118

NOMENCLATURE

	REF/SKU	DESIGNATION (FR)	DESIGNATION (UK)	PP
1	SGF412501	Verre saphir	Sapphire crystal	290.00
2	SGF411201	Joint de verre	Gasket for glass	6.00
3	SGF412702	Capsule SLN	SLN capsule	7.00
4	SGF411703	Lunette	Bezel	680.00
5	SGF411901	Ressort de lunette	Bezel spring	11.00
6	SGF412301	Tube 12h	12H Tube	11.00
7	SGF410601	Boîte	Watch case	590.00
8	SGF410401	Cliquet à pivot	Spring loaded ball	45.00
9	SGF410104	Aiguilles magnum	Magnum Hands	70.00
10	SGF410704	Cadran	Dial	330.00
11	SGF412601	Vis de fixation mouvement	Movement fixing screw	6.00
12	SGF410801	Cercle d'emboîtement	Coupler circle	60.00
13	SGF412001	Ressort de cercle d'emboîtement	Circle fitting spring	30.00
14	SGF411401	Joint de fond	Caseback O'ring	5.00
15	SGF411101	Fond de boîtier central	Central caseback part	55.00
16	SGF410301	Bague de fond	Caseback ring	50.00
17	SGF411601	kit x4 vis Allen	Set of x4 Allen screws	80.00
18	SGF412201	Tube de couronne	Steel crown tube	30.00
19	SGF411301	Joint de couronne	Crown O'ring	5.00
20	SGF410901	Couronne	Crown	70.00
21	SGF410201	Anse NATO	NATO end	60.00
22	SGF412401	Tube 6H	6H Tube	11.00
23	SGF411801	Mouvement	Movement	890.00
24	SGF411002	Disque de date	Date disk	35.00
25	SGF412101	Tige de remontoir	Winding stem	11.00
26	SGF410504	Boîte complete	Watch case set	1830.00
27	SGF411501	Kit montage Nato/Cuir	Set of Nato/Leather strap assembly	170.00

.77



1964 SPIRIT

78.



GF40215

NOMENCLATURE

	REF/SKU	DESIGNATION (FR)	DESIGNATION (UK)	PP
1	SGF40132	Verre saphir	Sapphire crystal	390.00
2	SGF400014	Joint de verre	Gasket for glass	6.00
3	SGF40129	Capsule SLN	SLN capsule	7.00
4	SGF40125	Lunette acier	Steel bezel	680.00
5	SGF400024	Ressort de lunette	Bezel spring	11.00
6	SGF400050	Kit axe + vis triangle	Set of triangle axis + screw	25.00
7	SGF40142	Boîtier complet	Watch case set	1830.00
8	SGF400106	Cliquet à pivot	Spring loaded ball	45.00
9	SGF40127	Réhaut	Dial ring	30.00
10	SGF40124	Aiguilles Magnum	Magnum hands	70.00
11	SGF400110	Cadran	Dial	110.00
12	SGF400244	Vis de fixation mouvement	Movement fixing screw	6.00
13	SGF400017	Cercle d'emboîtement	Coupler circle	60.00
14	SGF400034	Ressort de cercle d'emboîtement	Circle fitting spring	30.00
15	SGF400036	Joint de fond	O'ring caseback	5.00
16	SGF400035	Fond de Boîtier	Caseback	80.00
17	SGF400047	Kit x4 vis triangle	Set of x4 triangle screws	60.00
18	SGF400012	Tube de couronne	Steel crown tube	30.00
19	SGF400010	Couronne	Crown	70.00
20	SGF400009	Anse NATO	NATO end	60.00
21	SGF400045	Kit axe + vis fendus	Set of slotted axis + screw	25.00
22	SGF41801	Mouvement	Movement	890.00
23	SGF40130	Tige de remontoir GF300	Winding stem	11.00
24	ZBSS020	Boucle acier 20mm	Steel buckle 20mm	35.00
25	SGF4018M	Bracelet cuir, taille M	Leather strap, M size	150.00

.79



1964 SPIRIT

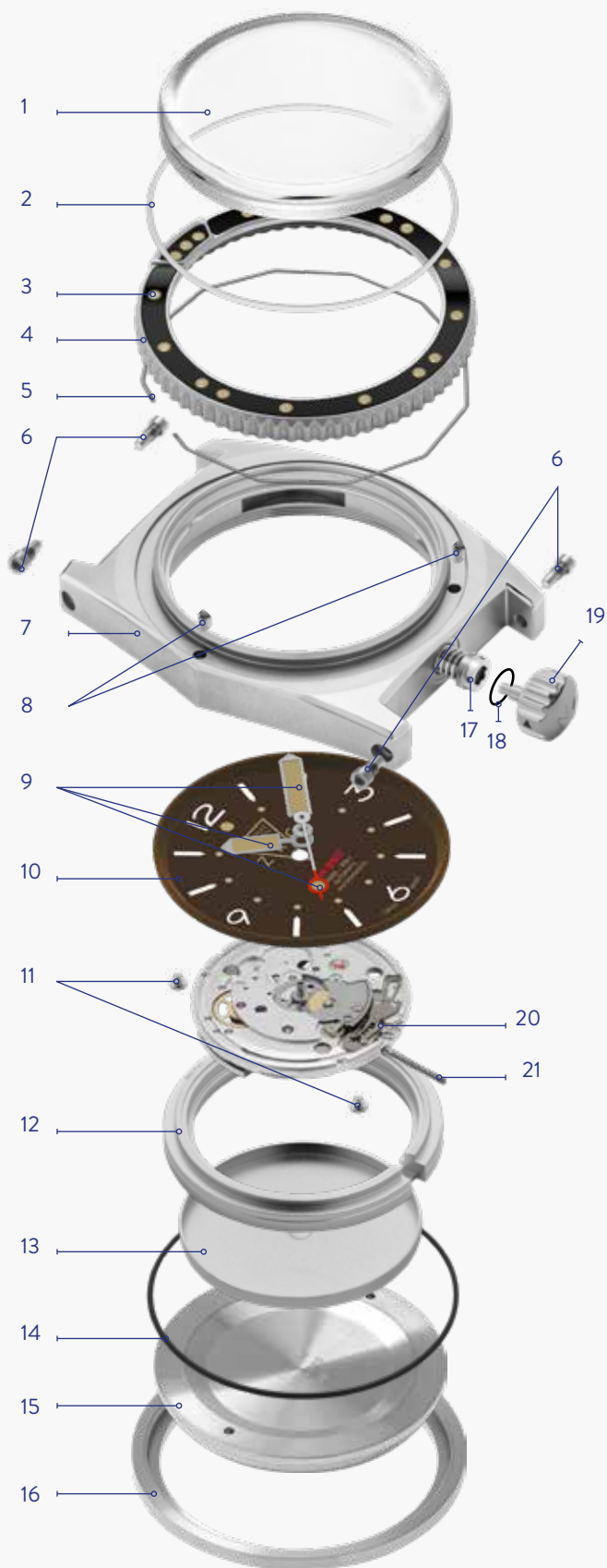

80.



GF41213

NOMENCLATURE

	REF/SKU	DESIGNATION (FR)	DESIGNATION (UK)	PP
1	SGF412502	Verre saphir	Sapphire crystal	390.00
2	SGF411201	Joint de verre	Gasket for glass	6.00
3	SGF412704	Capsule SLN	SLN capsule	7.00
4	SGF411706	Lunette	Bezel	680.00
5	SGF411901	Ressort de lunette	Bezel spring	11.00
6	SGF411601	kit x4 vis Allen	Set of x4 Allen screws	80.00
7	SGF410601	Boîte	Watch case	590.00
8	SGF410401	Cliquet à pivot	Spring loaded ball	45.00
9	SGF410103	Aiguilles magnum	Magnum Hands	70.00
10	SGF410708	Cadran	Dial	150.00
11	SGF412601	Vis de fixation mouvement	Movement fixing screw	6.00
12	SGF410801	Cercle d'emboîtement	Coupler circle	60.00
13	SGF412001	Ressort de cercle d'emboîtement	Circle fitting spring	30.00
14	SGF411401	Joint de fond	O'ring caseback	5.00
15	SGF411101	Fond de boîtier central	Central caseback part	55.00
16	SGF410301	Bague de fond	Caseback ring	50.00
17	SGF412201	Tube de couronne	Steel crown tube	30.00
18	SGF411301	Joint de couronne	Crown O'ring	5.00
19	SGF410901	Couronne	Crown	70.00
20	SGF411802	Mouvement	Movement	890.00
21	SGF412101	Tige de remontoir	Winding stem	11.00
22	SGF410505	Boîte complete	Watch case set	1830.00
23	SGF4116	Bracelet métal	Metal band	750.00

.81



1964 SPIRIT



82.

GF41218

NOMENCLATURE

	REF/SKU	DESIGNATION (FR)	DESIGNATION (UK)	PP
1	SGF412502	Verre saphir	Sapphire crystal	390.00
2	SGF411201	Joint de verre	Gasket for glass	6.00
3	SGF412704	Capsule SLN	SLN capsule	7.00
4	SGF411706	Lunette	Bezel	680.00
5	SGF411901	Ressort de lunette	Bezel spring	11.00
6	SGF412301	Tube 12h	12H Tube	11.00
7	SGF410601	Boîte	Watch case	590.00
8	SGF410401	Cliquet à pivot	Spring loaded ball	45.00
9	SGF410103	Aiguilles magnum	Magnum Hands	70.00
10	SGF410709	Cadran	Dial	150.00
11	SGF412601	Vis de fixation mouvement	Movement fixing screw	6.00
12	SGF410801	Cercle d'emboîtement	Coupler circle	60.00
13	SGF412001	Ressort de cercle d'emboîtement	Circle fitting spring	30.00
14	SGF411401	Joint de fond	Caseback O'ring	6.00
15	SGF411101	Fond de boîtier central	Central caseback part	55.00
16	SGF410301	Bague de fond	Caseback ring	50.00
17	SGF411601	kit x4 vis Allen	Set of x4 Allen screws	80.00
18	SGF412201	Tube de couronne	Steel crown tube	30.00
19	SGF411301	Joint de couronne	Crown O'ring	6.00
20	SGF410901	Couronne	Crown	70.00
21	SGF410201	Anse NATO	NATO end	60.00
22	SGF412401	Tube 6H	6H Tube	11.00
23	SGF411801	Mouvement	Movement	890.00
24	SGF411001	Disque de date	Date disk	35.00
25	SGF412101	Tige de remontoir	Winding stem	11.00
26	SGF410506	Boîte complete	Watch case set	1 830.00
27	SGF411501	Kit montage Nato/Cuir	Set of Nato/Leather strap assembly	170.00

.83



GF38 - HERITAGE

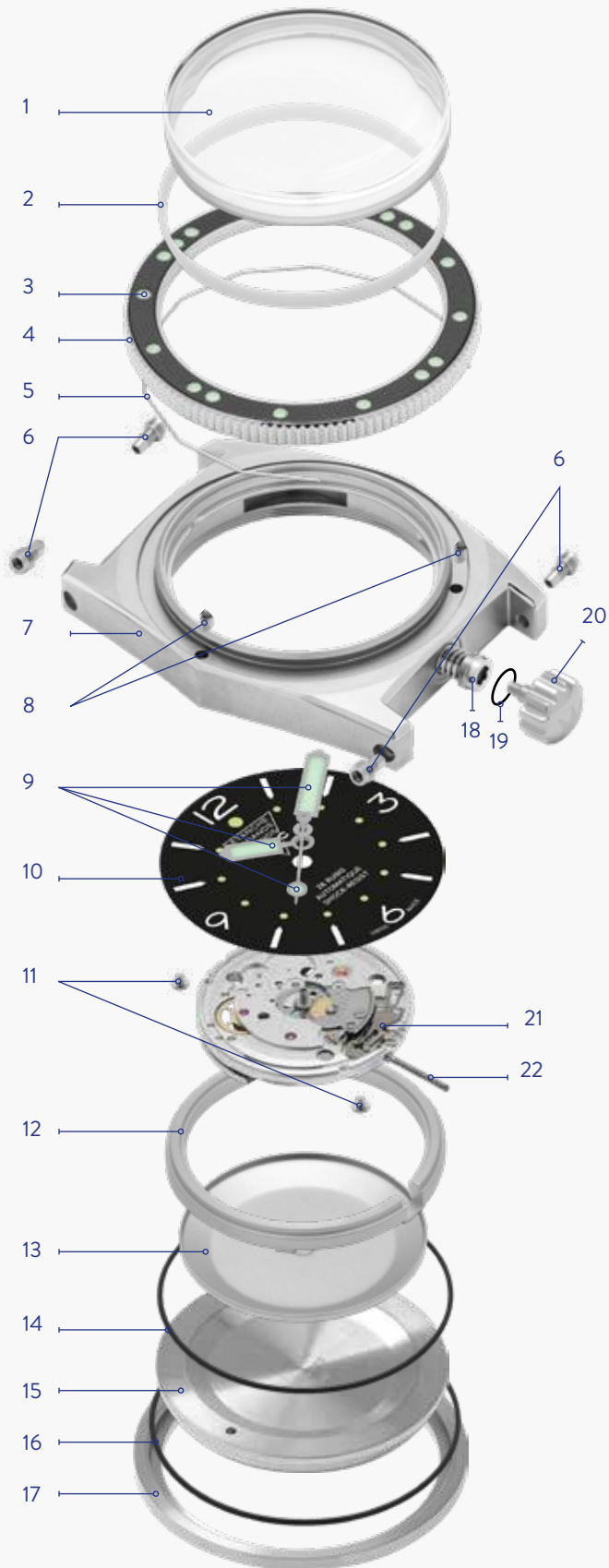

GF38163

NOMENCLATURE

	REF/SKU	DESIGNATION (FR)	DESIGNATION (UK)	PP
1	SGF382501	Verre saphir	Sapphire crystal	390.00
2	SGF381201	Joint de verre	Gasket for glass	6.00
3	SGF382701	Capsule SLN	SLN capsule	7.00
4	SGF381701	Lunette	Bezel	600.00
5	SGF381901	Ressort de lunette	Bezel spring	11.00
6	SGF411601	kit x4 vis Allen	Set of x4 Allen screws	80.00
7	SGF380601	Carrure	Watch case	260.00
8	SGF410401	Cliquet à pivot	Spring loaded ball	45.00
9	SGF380101	Aiguilles magnum	Magnum Hands	70.00
10	SGF380701	Cadran	Dial	150.00
11	SGF400245	Vis de fixation mouvement	Movement fixing screw	6.00
12	SGF380801	Cercle d'emboîtement	Coupler circle	60.00
13	SGF382001	Ressort de cercle d'emboîtement	Circle fitting spring	30.00
14	SGF382801	Joint de fond extérieur	External case back ring	5.00
15	SGF381101	Fond de boîtier central	Central caseback	55.00
16	SGF381401	Joint de fond central	Central case back ring	5.00
17	SGF380301	Bague de fond	Caseback ring	50.00
18	SGF382201	Tube de couronne	Steel crown tube	30.00
19	SGF381301	Joint de couronne	Crown O'ring	5.00
20	SGF380901	Couronne	Crown	70.00
21	SGF411802	Mouvement	Movement	890.00
22	SGF412101	Tige de remontoir	Winding stem	11.00
23	SGF380501	Boîte complete	Watch case set	1600.00
24	SGF381501	Kit de montage Nato/Cuir	Set of Nato/Leather strap assembly	170.00

.85



GF38 - HERITAGE

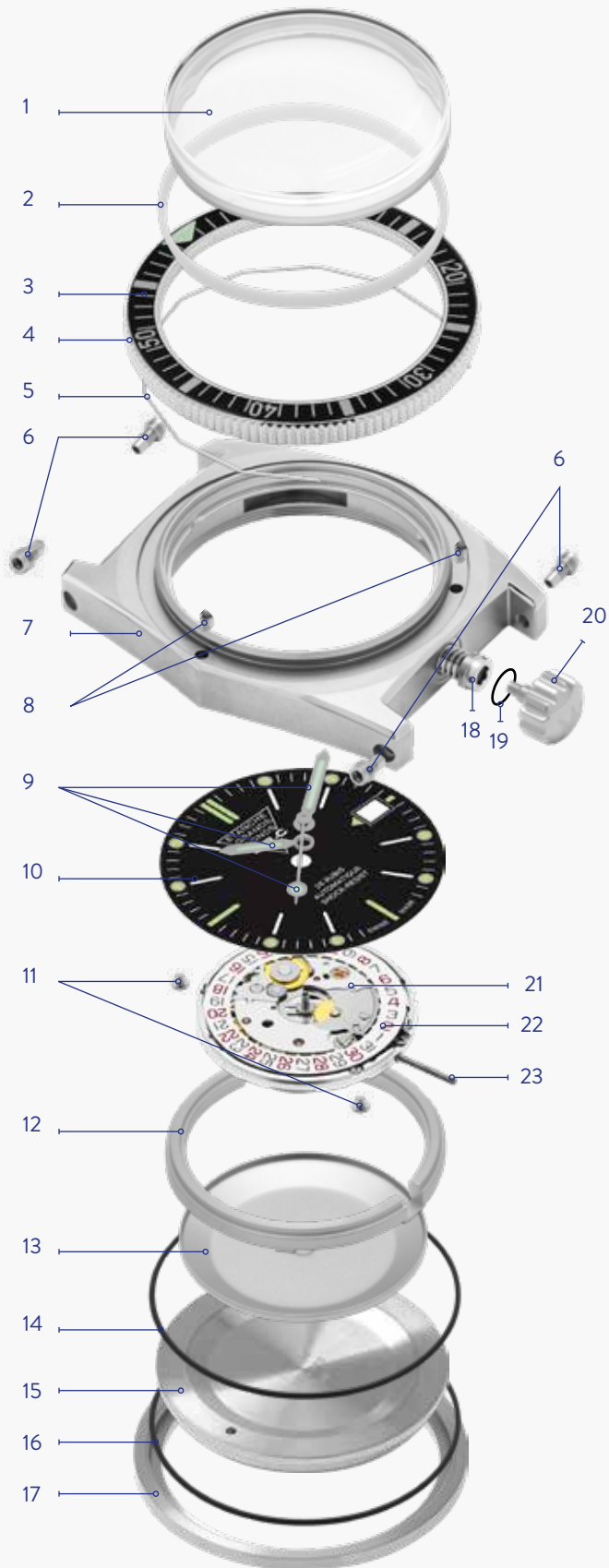

86.



GF38263

NOMENCLATURE

	REF/SKU	DESIGNATION (FR)	DESIGNATION (UK)	PP
1	SGF382501	Verre saphir	Sapphire crystal	390.00
2	SGF381201	Joint de verre	Gasket for glass	6.00
3	SGF382701	Capsule SLN	SLN capsule	7.00
4	SGF381702	Lunette	Bezel	600.00
5	SGF381901	Ressort de lunette	Bezel spring	11.00
6	SGF411601	kit x4 vis Allen	Set of x4 Allen screws	80.00
7	SGF380601	Carrure	Watch case	260.00
8	SGF410401	Cliquet à pivot	Spring loaded ball	45.00
9	SGF380102	Aiguilles magnum	Magnum Hands	70.00
10	SGF380702	Cadran	Dial	150.00
11	SGF400245	Vis de fixation mouvement	Movement fixing screw	6.00
12	SGF380801	Cercle d'emboîtement	Coupler circle	60.00
13	SGF382001	Ressort de cercle d'emboîtement	Circle fitting spring	30.00
14	SGF382801	Joint de fond extérieur	External case back ring	5.00
15	SGF381101	Fond de boîtier central	Central caseback	55.00
16	SGF381401	Joint de fond central	Central case back ring	5.00
17	SGF380301	Bague de fond	Caseback ring	50.00
18	SGF382201	Tube de couronne	Steel crown tube	30.00
19	SGF381301	Joint de couronne	Crown O'ring	5.00
20	SGF380901	Couronne	Crown	70.00
21	SGF411801	Mouvement	Movement	890.00
22	SGF381001	Disque de date	Date disk	35.00
23	SGF412101	Tige de remontoir	Winding stem	11.00
24	SGF380502	Boîte complete	Watch case set	1600.00
25	SGF381501	Kit de montage Nato/Cuir	Set of Nato/Leather strap assembly	170.00

.87



GF38 - HERITAGE

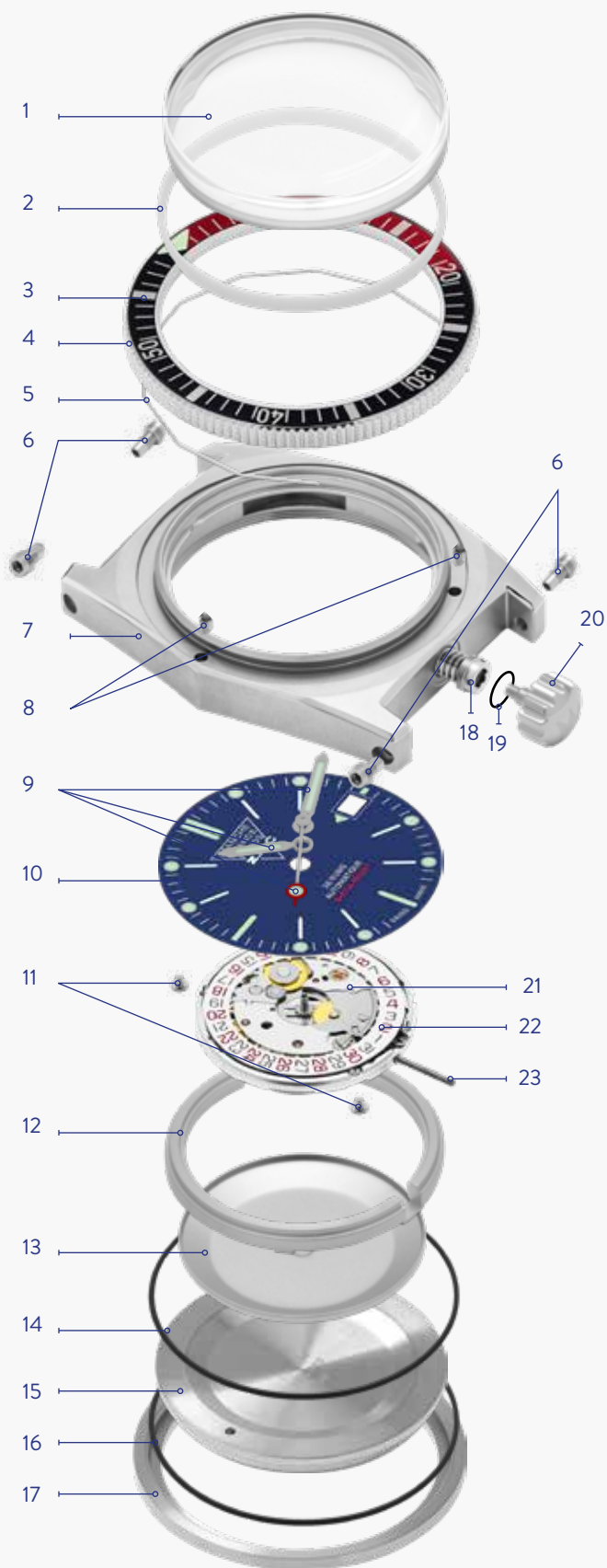

88.



NEW

GF38293

NOMENCLATURE

	REF/SKU	DESIGNATION (FR)	DESIGNATION (UK)	PP
1	SGF382501	Verre saphir	Sapphire crystal	390.00
2	SGF381201	Joint de verre	Gasket for glass	6.00
3	SGF382701	Capsule SLN	SLN capsule	7.00
4	SGF381703	Lunette	Bezel	600.00
5	SGF381901	Ressort de lunette	Bezel spring	11.00
6	SGF411601	kit x4 vis Allen	Set of x4 Allen screws	80.00
7	SGF380601	Carrure	Watch case	260.00
8	SGF410401	Cliquet à pivot	Spring loaded ball	45.00
9	SGF380103	Aiguilles magnum	Magnum Hands	70.00
10	SGF380703	Cadran	Dial	150.00
11	SGF400245	Vis de fixation mouvement	Movement fixing screw	6.00
12	SGF380801	Cercle d'emboîtement	Coupler circle	60.00
13	SGF382001	Ressort de cercle d'emboîtement	Circle fitting spring	30.00
14	SGF382801	Joint de fond extérieur	External case back ring	5.00
15	SGF381101	Fond de boîtier central	Central caseback	55.00
16	SGF381401	Joint de fond central	Central case back ring	5.00
17	SGF380301	Bague de fond	Caseback ring	50.00
18	SGF382201	Tube de couronne	Steel crown tube	30.00
19	SGF381301	Joint de couronne	Crown O'ring	5.00
20	SGF380901	Couronne	Crown	70.00
21	SGF411801	Mouvement	Movement	890.00
22	SGF381001	Disque de date	Date disk	35.00
23	SGF412101	Tige de remontoir	Winding stem	11.00
24	SGF380503	Boîte complete	Watch case set	1600.00
25	SGF381501	Kit de montage Nato/Cuir	Set of Nato/Leather strap assembly	170.00

.89



GF3000 TITANE

GF3000 TITANIUM



GF50608

NOMENCLATURE

	REF/SKU	DESIGNATION (FR)	DESIGNATION (UK)	PP
1	SGF500242	Verre saphir	Sapphire crystal	390.00
2	SGF500246	Joint de verre	Gasket for glass	6.00
3	SGF500239	Lunette titane	Titanium bezel	650.00
4	SGF500248	Ressort de lunette	Bezel spring	11.00
5	SGF500266	Tube 12h titane	Titanium 12h tube	11.00
6	SGF500250	Boîtier complet titane	Titanium watch case set	2900.00
7	SGF500249	Cliquet à pivot	Spring loaded ball	45.00
8	SGF500237	Aiguilles Magnum	Magnum hands	70.00
9	SGF500235	Cadran	Dial	115.00
10	SGF500255	Réhaut	Dial ring	35.00
11	SGF400245	Vis de fixation mouvement	Movement fixing screw	6.00
12	SGF500253	Cercle d'emboîtement	Coupler circle	60.00
13	SGF500254	Ressort de cercle d'emboîtement	Circle fitting spring	30.00
14	SGF500245	Joint de fond	O'ring caseback	6.00
15	SGF500257	Fond de Boîtier central	Central caseback part	125.00
16	SGF500259	Bague de fond titane	Titanium caseback ring	195.00
17	SGF500221	Kit x2 vis ALLEN titane	Titanium set of x2 ALLEN screws	55.00
18	SGF400012	Tube de couronne	Steel crown tube	30.00
19	SGF500247	Joint de couronne	Crown O ring	6.00
20	SGF500232	Couronne titane	Titanium crown	95.00
21	SGF500229	Anse titane pour caoutchouc	Titanium end for rubber	65.00
22	SGF500265	Tube 6h titane	Titanium 6h tube	11.00
23	SGF411802	Mouvement	Movement	890.00
24	SGF500244	Tige de remontoir	Winding stem	11.00
25	ZBTI020	Boucle titane satinée	Satined titanium buckle	70.00
26	SGF5006M	Bracelet caoutchouc, M	Rubber strap, M size	130.00
27	SGF500262	Kit x2 tubes titane	Titanium Set of x2 tubes	25.00



GF3000 TITANE

GF3000 TITANIUM



GF50618

NOMENCLATURE

	REF/SKU	DESIGNATION (FR)	DESIGNATION (UK)	PP
1	SGF500242	Verre saphir	Sapphire crystal	390.00
2	SGF500246	Joint de verre	Gasket for glass	6.00
3	SGF500240	Lunette titane	Titanium bezel	650.00
4	SGF500248	Ressort de lunette	Bezel spring	11.00
5	SGF500266	Tube 12h titane	Titanium 12h tube	11.00
6	SGF500251	Boîtier complet titane	Titanium watch case set	2900.00
7	SGF500249	Cliquet à pivot	Spring loaded ball	45.00
8	SGF500237	Aiguilles Magnum	Magnum hands	70.00
9	SGF500235	Cadran	Dial	115.00
10	SGF500255	Réhaut	Dial ring	35.00
11	SGF400245	Vis de fixation mouvement	Movement fixing screw	6.00
12	SGF500253	Cercle d'emboîtement	Coupler circle	60.00
13	SGF500254	Ressort de cercle d'emboîtement	Circle fitting spring	30.00
14	SGF500245	Joint de fond	O'ring caseback	6.00
15	SGF500264	Fond de Boîtier central	Central caseback part	125.00
16	SGF500260	Bague de fond titane	Titanium caseback ring	195.00
17	SGF500222	Kit x2 vis ALLEN titane	Titanium set of x2 ALLEN screws	55.00
18	SGF400012	Tube de couronne	Steel crown tube	30.00
19	SGF500247	Joint de couronne	Crown O ring	6.00
20	SGF500233	Couronne titane	Titanium crown	95.00
21	SGF500230	Anse titane sablée pour caoutchouc	Sandblasted titanium end for rubber	65.00
22	SGF500265	Tube 6h	Titanium 6h tube	11.00
23	SGF411802	Mouvement	Movement	890.00
24	SGF500244	Tige de remontoir GF3000	Winding stem	11.00
25	ZBTI320	Boucle titane sablée	Sandblasted titanium buckle	70.00
26	SGF5006M	Bracelet caoutchouc, M	Rubber strap, M size	130.00
27	SGF500262	Kit x2 tubes titane	Titanium Set of x2 tubes	25.00



GF3000 TITANE

GF3000 TITANIUM



94.

GF50678

NOMENCLATURE

	REF/SKU	DESIGNATION (FR)	DESIGNATION (UK)	PP
1	SGF500242	Verre saphir	Sapphire crystal	390.00
2	SGF500246	Joint de verre	Gasket for glass	6.00
3	SGF500241	Lunette titane	Titanium bezel	670.00
4	SGF500248	Ressort de lunette	Bezel spring	11.00
5	SGF500266	Tube 12h titane	Titanium 12h tube	11.00
6	SGF500252	Boîtier complet titane	Titanium watch case set	3090.00
7	SGF500249	Cliquet à pivot	Spring loaded ball	45.00
8	SGF500238	Aiguilles Magnum	Magnum hands	80.00
9	SGF500236	Cadran	Dial	115.00
10	SGF500256	Réhaut	Dial ring	35.00
11	SGF400245	Vis de fixation mouvement	Movement fixing screw	6.00
12	SGF500253	Cercle d'emboîtement	Coupler circle	60.00
13	SGF500254	Ressort de cercle d'emboîtement	Circle fitting spring	30.00
14	SGF500245	Joint de fond	O'ring caseback	6.00
15	SGF500258	Fond de Boîtier central	Central caseback part	150.00
16	SGF500261	Bague de fond titane	Titanium caseback ring	230.00
17	SGF500223	Kit x2 vis Allen titane	Titanium set of x2 Allen screws	80.00
18	SGF400012	Tube de couronne	Steel crown tube	30.00
19	SGF500247	Joint de couronne	Crown O ring	6.00
20	SGF500234	Couronne titane	Titanium crown	110.00
21	SGF500231	Anse titane pour caoutchouc	Sandblasted titanium DLC end for rubber	85.00
22	SGF500265	Tube 6h titane	Titanium 6h tube	11.00
23	SGF411802	Mouvement	Movement	890.00
24	SGF500244	Tige de remontoir	Winding stem	11.00
25	ZBTI220	Boucle titane sablée	Sandblasted titanium buckle	90.00
26	SGF5001M	Bracelet caoutchouc, M	Rubber strap, M size	130.00
27	SGF500262	Kit x2 tubes titane titane	Titanium Set of x2 tubes	25.00



GF3000 TITANE

GF3000 TITANIUM



96.

GF50698

NOMENCLATURE

	REF/SKU	DESIGNATION (FR)	DESIGNATION (UK)	PP
1	SGF500242	Verre saphir	Sapphire crystal	390.00
2	SGF500246	Joint de verre	Gasket for glass	6.00
3	SGF500273	Lunette titane	Titanium bezel	650.00
4	SGF500248	Ressort de lunette	Bezel spring	11.00
5	SGF500266	Tube 12h titane	Titanium 12h tube	11.00
6	SGF500274	Boîtier complet titane	Titanium watch case set	2900.00
7	SGF500249	Cliquet à pivot	Spring loaded ball	45.00
8	SGF500272	Aiguilles Magnum	Magnum hands	70.00
9	SGF500271	Cadran	Dial	115.00
10	SGF500276	Réhaut	Dial ring	35.00
11	SGF400245	Vis de fixation mouvement	Movement fixing screw	6.00
12	SGF500253	Cercle d'emboîtement	Coupler circle	60.00
13	SGF500254	Ressort de cercle d'emboîtement	Circle fitting spring	30.00
14	SGF500245	Joint de fond	O'ring caseback	5.00
15	SGF500257	Fond de Boîtier central	Central caseback part	125.00
16	SGF500259	Bague de fond titane	Titanium caseback ring	195.00
17	SGF500221	Kit x2 vis ALLEN titane	Titanium set of x2 ALLEN screws	55.00
18	SGF400012	Tube de couronne	Steel crown tube	30.00
19	SGF500247	Joint de couronne	Crown O ring	6.00
20	SGF500232	Couronne	Titanium crown	95.00
21	SGF500229	Anse titane pour caoutchouc	End for rubber	65.00
22	SGF500265	Tube 6h titane	Titanium 6h tube	11.00
23	SGF411802	Mouvement	Movement	890.00
24	SGF500244	Tige de remontoir GF3000	Winding stem	11.00
25	ZBTI020	Boucle titane satinée	Satined titanium buckle	70.00
26	SGF5009M	Bracelet caoutchouc, M	Rubber strap, M size	130.00
27	SGF500262	Kit x2 tubes titane	Titanium Set of x2 tubes	25.00

.97



GF3000 TITANE

GF3000 TITANIUM



98.

NEW

GF50699

NOMENCLATURE

	REF/SKU	DESIGNATION (FR)	DESIGNATION (UK)	PP
1	SGF500242	Verre saphir	Sapphire crystal	390.00
2	SGF500246	Joint de verre	Gasket for glass	6.00
3	SGF500270	Lunette titane	Titanium bezel	650.00
4	SGF500248	Ressort de lunette	Bezel spring	11.00
5	SGF500266	Tube 12h titane	Titanium 12h tube	11.00
6	SGF500283	Boîtier complet titane	Titanium watch case set	2900.00
7	SGF500249	Cliquet à pivot	Spring loaded ball	45.00
8	SGF500284	Aiguilles Magnum	Magnum hands	70.00
9	SGF500285	Cadran	Dial	170.00
10	SGF500286	Réhaut	Dial ring	35.00
11	SGF400245	Vis de fixation mouvement	Movement fixing screw	6.00
12	SGF500253	Cercle d'emboîtement	Coupler circle	60.00
13	SGF500254	Ressort de cercle d'emboîtement	Circle fitting spring	30.00
14	SGF500245	Joint de fond	O'ring caseback	6.00
15	SGF500264	Fond de Boîtier central	Central caseback part	125.00
16	SGF500260	Bague de fond titane	Titanium caseback ring	195.00
17	SGF500222	Kit x2 vis ALLEN titane	Titanium set of x2 ALLEN screws	55.00
18	SGF400012	Tube de couronne	Steel crown tube	30.00
19	SGF500247	Joint de couronne	Crown O ring	6.00
20	SGF500233	Couronne titane	Titanium crown	95.00
21	SGF500230	Anse titane sablée pour caoutchouc	Sandblasted titanium end for rubber	65.00
22	SGF500265	Tube 6h titane	6h tube	11.00
23	SGF411802	Mouvement	Movement	890.00
24	SGF500244	Tige de remontoir	Winding stem	11.00
25	ZBTI320	Boucle titane sablée	Sandblasted titanium buckle	70.00
26	SGF5001M	Bracelet caoutchouc, M	Rubber strap, M size	130.00
27	SGF500262	Kit x2 tubes titane	Titanium Set of x2 tubes	25.00

.99



V1 (GF300) : SGF4016

VERSION SATINÉE - POLIS

SATINED & POLISHED VERSION

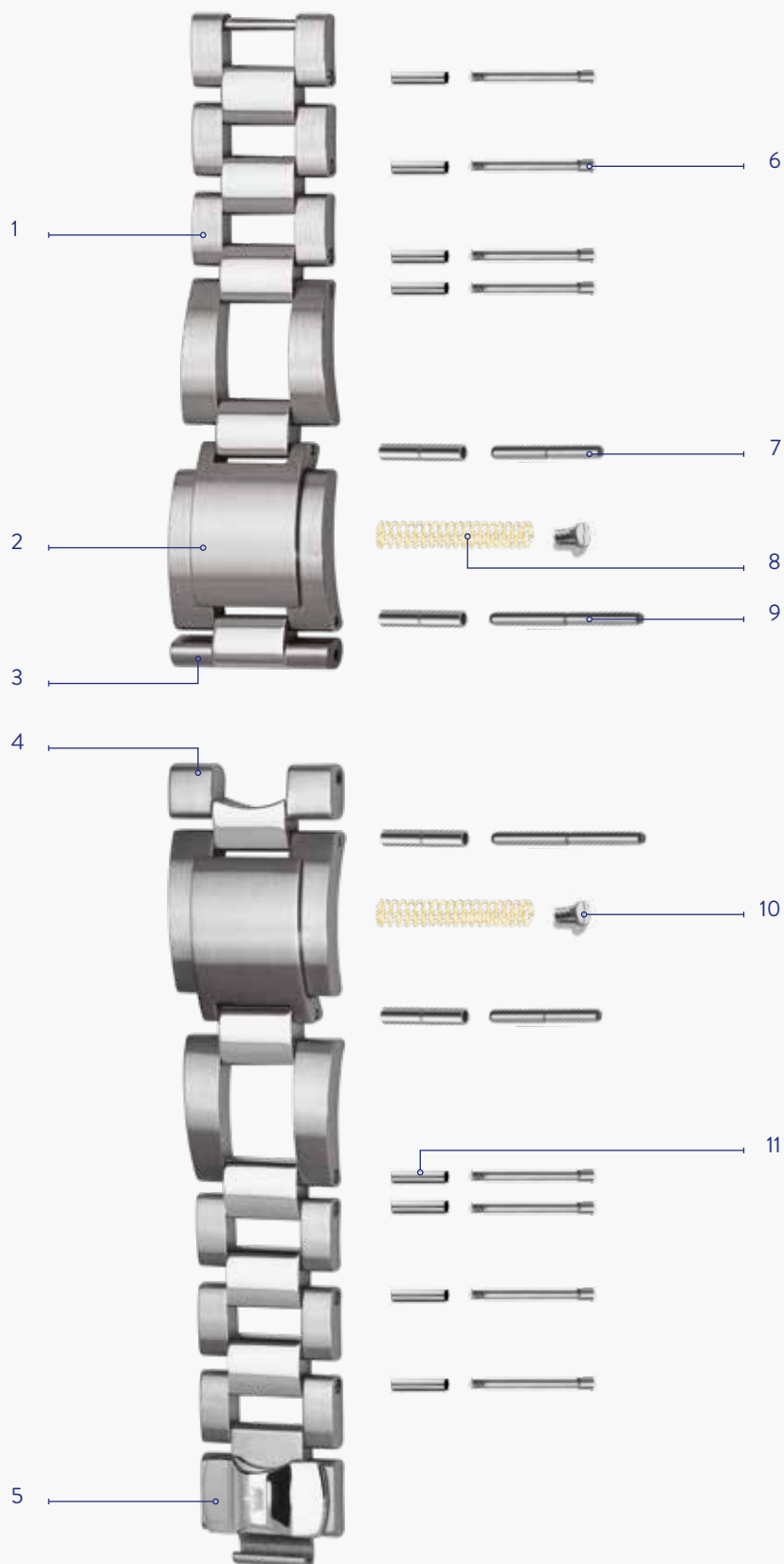

DÉTAILS BRACELETS MÉTAL

METAL BAND DETAILS

	REF/SKU	DESIGNATION (FR)	DESIGNATION (UK)	PP
1	SGF400028	Maillon de réglage	Sizing link	85.00
2	SGF400030	Maille extensible	Dive extension link	115.00
3	SGF400033	Anse métal 12H	Metal end 12H	65.00
4	SGF400026	Anse métal 6H	Metal end 6H	65.00
5	SGF400027	Fermeoir	Clasp	135.00
6	SGF400029	Vis de maillon	Screw link	11.00
7	SGF400031	Goupille CAPSA maillon	Link CAPSA pin	6.00
8	SGF400102	Ressort	Spring	9.00
9	SGF400250	CAPSA anse	End CAPSA pin	6.00
10	SGF400208	Vis de capot	Cover screw	6.00
11	SGF400209	Tube de maillon	Mid link tube	6.00

.101



SGF400047

Kit de 4 vis triangle / Set of 4 triangle screws
(Vis non fournies avec le bracelet métal)
(Screws not provided with the metal band)

PP
60.00



V2 (GF300) : SGF4116

VERSION COMPLÈTEMENT SATINÉE
FULL SATINATED VERSION

Demi maillon fermoir
1/2 clasp link

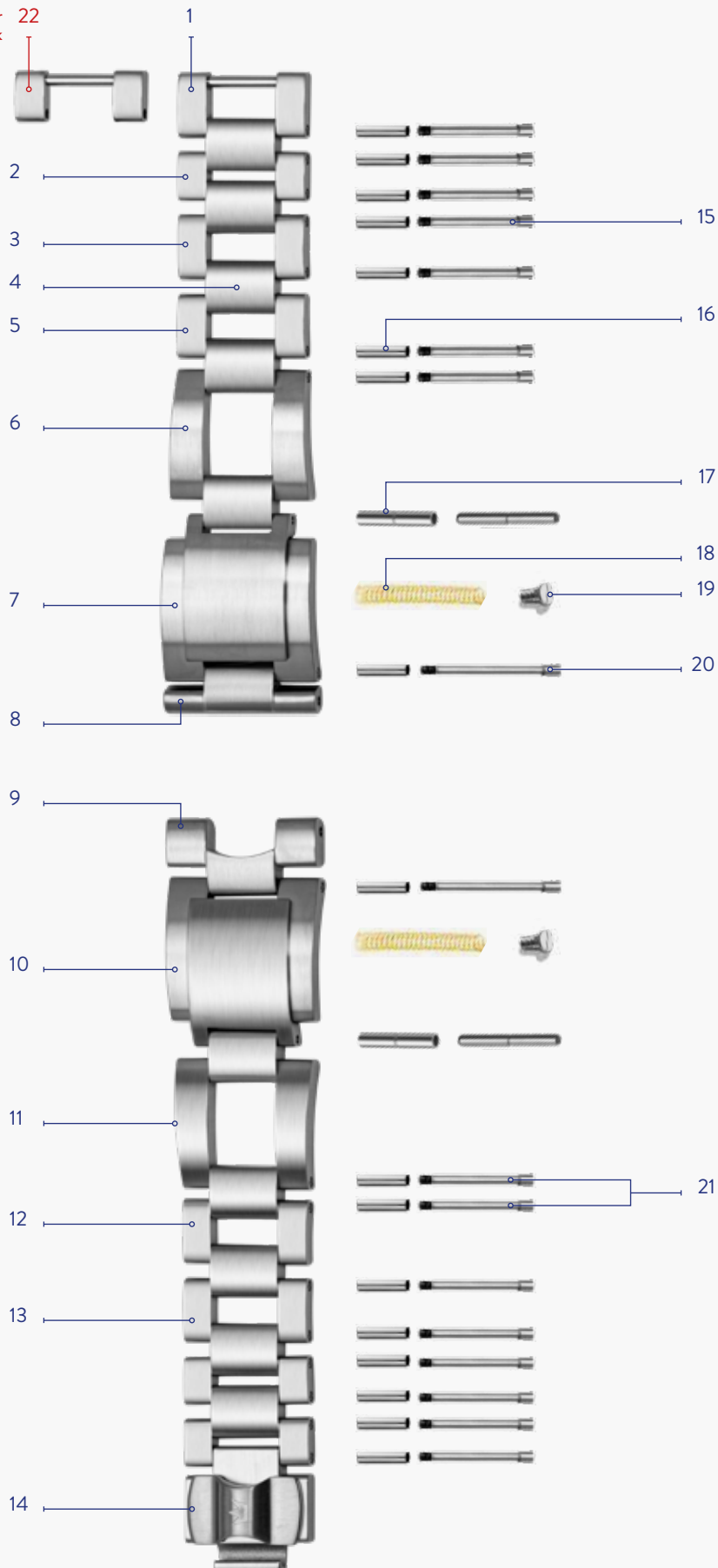

102.

DÉTAILS BRACELETS MÉTAL

METAL BAND DETAILS

	REF/SKU	DESIGNATION (FR)	DESIGNATION (UK)	PP
1	SGF400221	Maillon fermoir 12H - 1 vis 1 tube	12H clasp link 1 screw 1 tube	85.00
2	SGF40118	Demi maillon	1/2 link	85.00
3	SGF400235	Maille intermédiaire 2 vis + 2 tubes 12H	2H mid link 2 screws + 2 tubes	85.00
4	SGF400224	Maille intermédiaire	Mid link	85.00
5	SGF400225	Maillon ajustable 12H 2 vis + 2 tubes	12H sizable link 2 screws + 2 tubes	85.00
6	SGF400223	Maillon en chute 12H	Tapered 12H link	85.00
7	SGF400222	Maillon Extensible 12H	Dive extension 12H	115.00
8	SGF400233	Anse 12h + tube	12H end + tube	70.00
9	SGF400227	Anse 6H + Tube	6H end + tube	70.00
10	SGF400228	Maillon extensible 6H	Dive extension 6H	115.00
11	SGF400229	Maillon en chute 6H	Tapered 6H link	85.00
12	SGF400226	Maille intermédiaire 2 vis + 2 tubes 6H	6H mid link 2 screws + 2 tubes	85.00
13	SGF400232	Maille intermédiaire 2 vis + 2 tubes 6H	6H mid link 2 screws + 2 tubes	85.00
14	SGF400234	Fermoir	Clasp	95.00
15	SGF400029	Vis de maillon	Link's screw	11.00
16	SGF400209	Tube de maillon	Mid link tube	6.00
17	SGF400230	Goupille Capsa + tube	Capsa pin + tube	6.00
18	SGF400231	Ressort	Spring	9.00
19	SGF400208	Vis de capot	Flap's screw	6.00
20	SGF40135	Vis maillon extensible	Dive extension screw	11.00
21	SGF400236	Kit 2 vis de maillons ajustables	Set of 2 screws link	25.00
22	SGF40133	Demi Maillon coté fernoir	1/2 clasp link	85.00

.103

info

DIFFERENCE V1 - V2

AMELIORATIONS - IMPROVEMENTS

	V1	V2
Réglage fin - Sharp sizing	•	•
Ressort renforcé - Reinforced spring		•
Vis à frein filet Epotime® - Screw with Epotime® threadlocker		•
Maille extensible vissée - Screwed dive extension link		•
Maillons supplémentaires - Additional links		•
Modularité des maillons - Links modularity		•
Finition satinée - Satin finishing		•
Têtes de vis améliorées - Improved screws heads		•
Testé en laboratoire 10 000 cycles de contraintes Laboratory-tested 10 000 cycles of stress		•



SGF400047

PP
60.00

Kit de 4 vis triangle / Set of 4 triangle screws
(Vis non fournies avec le bracelet métal)
(Screws not provided with the metal band)



SGF411601

PP
80.00

Kit de 4 vis Allen / Set of 4 Allen screws
(Vis non fournies avec le bracelet métal)
(Screws not provided with the metal band)



GF38 HERITAGE : SGF3816

VERSION COMPLÈTEMENT SATINÉE

FULL SATINATED VERSION

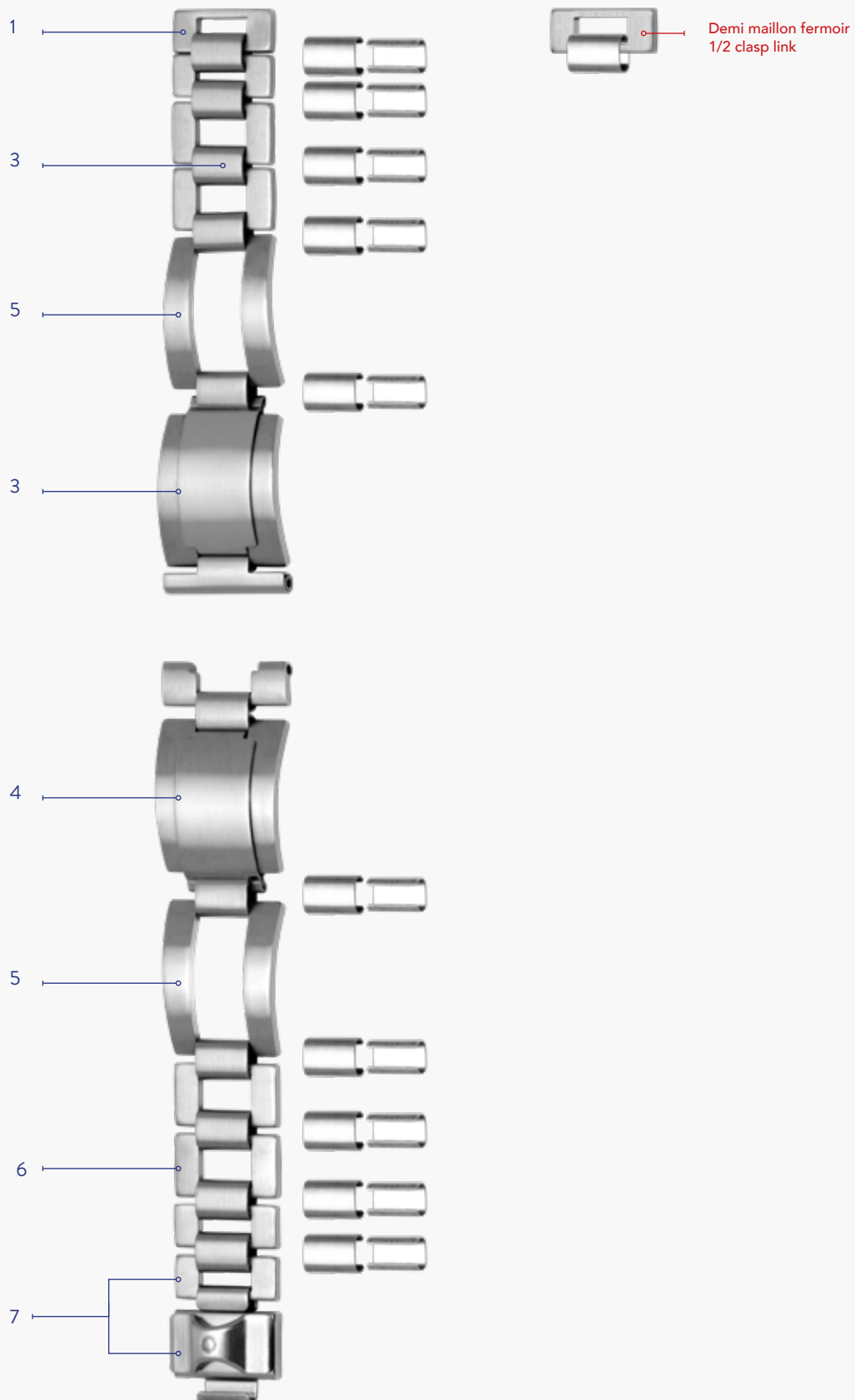

104.

DÉTAILS BRACELETS MÉTAL

METAL BAND DETAILS

	REF/SKU	DESIGNATION (FR)	DESIGNATION (UK)	PP
1	SGF383005	Demi-maillon d'ajustement	Sizable 1/2 link	18.00
2	SGF383006	Maillon de connexion	Connection link	15.00
3	SGF383002	Maillon extensible 12H	12H clasp link	55.00
4	SGF383001	Maillon extensible 6H	Dive extension 6H	55.00
5	SGF383003	Maillon en chute 6h & 12H	Dive extension 6H and 12H	25.00
6	SGF383004	Maillon d'ajustement	Sizable link	18.00
7	SGF383007	Fermeoir complet + demi-maillon 12H	Clasp + 1/2 link	60.00

.105



SGF381601

Kit de 4 vis Allen / Set of 4 Allen screws
(Vis non fournies avec le bracelet métal)
(Screws not provided with the metal band)

PP
80.00



OUTILS MARKETING

MARKETING TOOLS



106.



- 1 -
ZM1807

- 2 -
ZM1854

- 3 -
ZM1803

- 4 -
ZM1841

- 9 -
ZM1839

- 10 -
ZM1809

Pochette de présentation
Presentation folder
21x29,7 cm - (FR/UK)

Le livre de la montre
The brand book
14 x 14 cm - (FR/UK)

Dépliant collection
Collection leaflet
14 x 14 cm - (FR/UK)

Catalogue de travail
Retail catalog
21 x 29,7 cm - (FR/UK)

Tatouage GF3000
GF3000 tatoo
7,6 x 5,1 cm

Tatouage GF300
GF300 tatoo
7,6 x 5,1 cm

30.00 PP

10.00 PP

85.00 PP

15.00 PP

15.00 PP

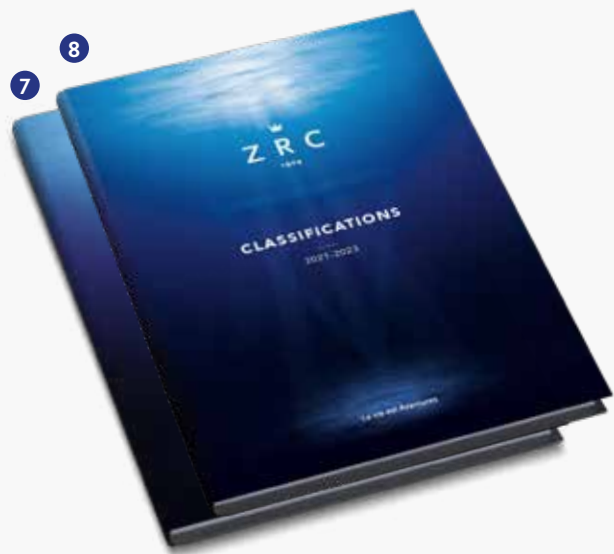

.107

- 5 -
ZM1840

Livre North Adventure
North Adventure book
21,5 x 27,5 cm - (FR/UK)

65.00 PP

- 6 -
ZM1870

Livre South Adventure
South Adventure book
21,5 x 27,5 cm - (FR/UK)

65.00 PP

- 7 -
ZM1855

Livre «Classifications»
2015-2020
Classifications book
2015-2020
21 x 29,7 cm - (FR/UK)

250.00 PP

- 8 -
ZM1876

Livre «Classifications»
2021-2023
Classifications book
2021-2023
21 x 29,7 cm - (FR/UK)

250.00 PP

PLV
DISPLAY



ZP62406

Présentoir 6 montres
6 watches display
27 x 27 x 35 cm

550.00 PP



ZP01SM

Image de PLV, taille "SM"
Display frame, size "SM"

Image verso - Back frame
27 x 35 x 2 cm

250.00 PP

108.



ZP82406 + ZP42406 (x2)

Présentation full 16 montres
16 watches full display

Suggestion
de présentation
Example of set up



ZP01S

Image de PLV, taille "S"
Display frame, size "S"

Image recto - Front frame
36 x 27 x 30 cm

250.00 PP



ZP82406

Présentoir 8 montres
8 watches display
36 x 27 x 6 cm

600.00 PP



ZP01M

Image de PLV, taille "M"
Display frame, size "M"

Image verso - Back frame
36 x 27 x 45 cm

250.00 PP



.109



ZP01L

Image de PLV, taille "L"
Display frame, size "L"

Image verso - Back frame
36 x 27 x 60 cm

250.00 PP



PLV
DISPLAY



ZP42406

PLV 4 montres
4 watches display
27 x 19 x 20 cm

400.00 PP

NEW



ZP03K

Présentoir Podium 3 montres
3 watches Podium display
20 x 6 x 12 cm

50.00 PP

110.



ZP1M032406

Toboggan
Slide
6 x 6 x 17 cm

60.00 PP



Rappel de Marque "Official dealer"
Brand display "Official dealer"
5 x 5 x 8 cm

Rappel de ligne GF3000
GF3000 line display
3 x 3 x 5 cm

Rappel ligne GF300
GF300 line display
3 x 3 x 5 cm

NEW

ZP02K

Rappel de marque
Brand display

25.00 PP



TO012406M

Totem présentoir - taille M
Totem display - size M
11 x 7 x 7 cm
50.00 PP

TO012406L

Totem présentoir - taille L
Totem display - size L
15 x 7 x 7 cm
50.00 PP

TO012406S

Totem présentoir - taille S
Totem display - size S
7 x 7 x 7 cm
50.00 PP



ZR70007

Plot montre
Watch stand
17 x ø6 cm
60.00 PP

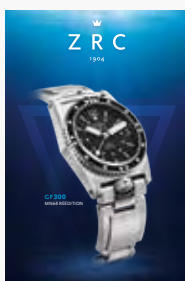

ZM1844

Visuel PLV GF300
1 montre
GF300 display picture
1 watch
12,1 x 18,5 cm
20.00 PP

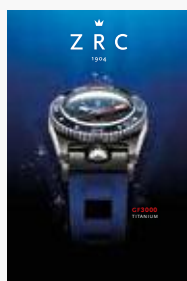

ZM1845

Visuel PLV GF3000
1 montre
GF3000 display picture
1 watch,
12,1 x 18,5 cm
20.00 PP



ZP1M012406

Présentoir
1 montre
1 watch display
12,1 x 18 x 3,6 cm
120.00 PP



ZP42406

Aile de présentoir
2 montres
Wings of display for 2 watches
19 x 27 x 3,6 cm
400.00 PP



ACCESSOIRES

ACCESSORIES



- 1 -
PO102406

Pochette SAV
After sale service pouch

30.00 PP

- 2 -
Mi002406

Miroir
Mirror
21 x 27 cm

100.00 PP

- 3 -
ZR70012

Selvit
30 x 30 cm

25.00 PP

- 4 -
ZR70011

Gants d'horloger
Watchmaker gloves

30.00 PP

- 5 -
PL012406

Plateau de présentation
Presentation tray
29 x 29 x 2,5 cm

50.00 PP

112.



6



7



8



9

- 6 -
ZR70010

Trousse outillage consommateurs
Consumers' tool kit

200.00 PP

- 7 -
ZR70009

Trousse outillage concessionnaires
Official dealers' tool kit

370.00 PP

- 8 -
ZR70022

Tournevis triangle
Triangle screwdriver

35.00 PP

- 9 -
ZR70027

Tournevis Allen
Allen screwdriver

35.00 PP



TARIF RÉPARATIONS

REPAIR TARIFF

REF.	INTERVENTIONS*	PP
ZWS001	Dépose et pose fond / Caseback replacement	55.00
ZWS002	Dépose et pose verre / Glass replacement	200.00
ZWS003	Dépose et pose aiguilles / Hands replacement	200.00
ZWS004	Dépose et pose lunette tournante / Bezel replacement	200.00
ZWS005	Dépose et pose mouvement / Movement replacement	305.00
ZWS006	Dépose et pose vis boîtier / Case' screws replacement	95.00
ZWS007	Dépose et pose bracelet / Strap replacement	95.00
ZWS008	Dépose maille pour changement ressort, pose maille (pour 1 maille) Dive extension' spring replacement	105.00
ZWS009	Dépose et pose couronne Crown replacement	125.00
ZWS010	Dépose et pose tige de remontoir Winding 'stem replacement	125.00
ZWS011	Dépose et pose tube de couronne Crown's tube replacement	125.00
ZWS012	Dépose et pose cadran (0H, 24H, contrôle de 48 heures) / Dial replacement*	380.00
ZWS013	Dépose et pose anse (6h / 12h) / Steel end (6h / 12h) replacement	95.00
ZWS014	Mise à longueur bracelet métal / Metal band sizing	95.00
ZWS015	Contrôle étanchéité / Waterproof control	160.00
ZWS016	Réglage mouvement / Movement Tuning (Sortie de boîte, passage au banc et contrôle étanchéité)	290.00
ZWS017	Avivage boîtier / Case polishing (Polissage doux + bain aux ultra-sons)	200.00
ZWS018	Avivage bracelet / Metal band polishing (Polissage doux + bain aux ultra-sons)	200.00
ZWS019	Révision complète / Full maintenance (Pose aiguille, pose cadran, si casse pièces détachées en supplément)	735.00
ZWS020	Pack accident sous-marin / Diving accident pack (Changement mouvement, changement aiguilles, changement cadran, changement joints, contrôle étanchéité / New hands, dial, movement, joints)	945.00
ZWS021	Frais prise en charge SAV (Transport interne) / Service charge	65.00
ZWS022	Retrait vis endommagée / Removing of damaged screw	160.00
ZWS027	Contrôle de réserve de marche / Power reserve control	160.00
ZWS031	Gravure / Engraving	305.00

114.

* Main d'œuvre seulement / Labor only



GRILLE DE MISE À TAILLE BRACELETS ZRC

ZRC STRAPS & BANDS SIZING INFORMATION

Ø Poignet Wrist cm	Bracelet ZRC / ZRC Strap				Commentaires / Comments
	Métal	Cuir	Nato	Rubber	
15	16,5	S (110x70)	S (105x70)	/	<p>Les tailles S couvrent les poignets de 15 à 18 cm - Prendre la circonférence du poignet au mètre de couturière. Pour le bracelet métal rajouter 1,5cm à cette mesure pour le réglage.</p> <p>The S sizes cover wrists diameter from 15 to 18cm. Please calculate it with a needlewomen meter. For the metal band add 1,5cm at this measurement.</p>
15,5	17				
16	17,5				
16,5	18				
17	18,5				
17,5	19				
18	19,5				
18	20	M (115x80)	SM (120x70)	M (115x70)	<p>Les tailles SM/M couvrent les poignets de 18 à 20 cm - Prendre la circonférence du poignet au mètre de couturière. Pour le bracelet métal rajouter 1,5cm à cette mesure pour le réglage.</p> <p>The SM/M sizes cover wrists diameter from 18 to 20 cm. Please calculate it with a needlewomen meter. For the metal band add 1,5cm at this measurement.</p>
19	20,5				
19,5	21				
20	21,5				
20	22	L (125x90)	M (135x70)	L (135x80)	<p>Les tailles L/M couvrent les poignets de 20 à 22 cm - Prendre la circonférence du poignet au mètre de couturière. Pour le bracelet métal rajouter 1,5cm à cette mesure pour le réglage.</p> <p>The L/M sizes cover wrists diameter from 20 to 22 cm. Please calculate it with a needlewomen meter. For the metal band add 1,5cm at this measurement.</p>
21	22,5				
21,5	23				
22	23,5				
22	/	/	L (165x90)	/	<p>Les tailles L couvrent les poignets de 22 à 25 cm - Prendre la circonférence du poignet au mètre de couturière. Pour le bracelet métal rajouter 1,5cm à cette mesure pour le réglage.</p> <p>The L sizes cover wrists diameter from 22 to 25 cm. Please calculate it with a needlewomen meter. For the metal band add 1,5cm at this measurement.</p>
23					
24					
25					

.115



CUIR : S : 110x70 mm / M : 115x80 mm / L : 125x90 mm
 NATO : S : 105x70 mm / SM : 120x70 mm / M : 135x70 mm / L : 165x90 mm
 CAOUTCHOUC : M : 115x70 mm / L : 135x80 mm



ZRC GENÈVE SA

Suisse

customerservice@zrc1904.ch

 ZRC.1904 •  ZRC1904

ZRC1904.COM